

Wolfpack instruction manual



Hosting a game	3
Joining a game	5
Basic controls	5
Overview	6
The Engine order telegraphs	10
Rudder controls	12
Diving and surfacing	13
Periscopes and the UZO	19
Examples	30
The TDC	31
Launching a single torpedo	32
Launching a salvo	32
The deck gun	32
The anti aircraft gun	34
The hydrophone station	35
The radio	36
The Enigma machine	38
The radio direction finder	40
The echo ranger	43

Hosting a game

1. In the main menu, press Play.
2. Choose lobby visibility using the dropdown menu below the New Lobby button.
3. Press the New Lobby button.
4. Use the sliders to set, month, year, and difficulty. Later during the war, convoys get bigger and more well defended. On higher difficulty levels the level objectives are harder to complete, and there are more escort ships.
5. To invite people to your game, press the invite button in the friends menu. Friends can also be invited when the game has been started, by pressing i when playing, invited via Steams friends interface, by pressing shift+tab.
6. To start the game, press start game. Other players may join the game after it has started.

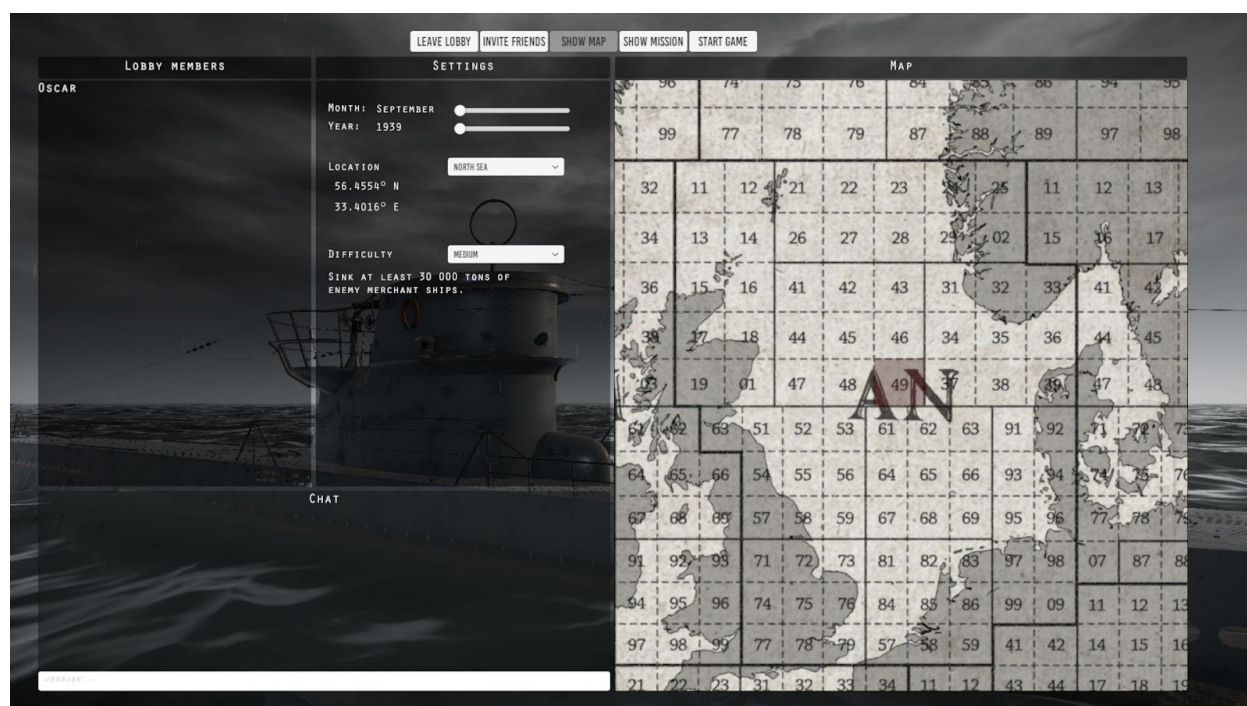

The lobby.

Joining a game

If a lobby's visibility settings is set to Public, or to Friends only, and you are friends with the lobby owner, the lobby will be visible to you in the Lobby list. To refresh the lobby list, press the Refresh Lobby List button. To join a private lobby, you need to be invited by a lobby member. If you are invited to a lobby, you will receive a popup message via Steam's standard chat interface (press shift+tab to show/hide).

The U-boat pen

Once you have hosted or joined a game, you will first enter the U-boat pen. This is where you choose your role. Once you have chosen a role you may choose to start the mission and launch your U-boat. Other players may join after the U-boat has been launched. If the U-boat is destroyed, the mission continues, and you may select another U-boat from the pen. If all four U-boats are destroyed, the mission is lost.

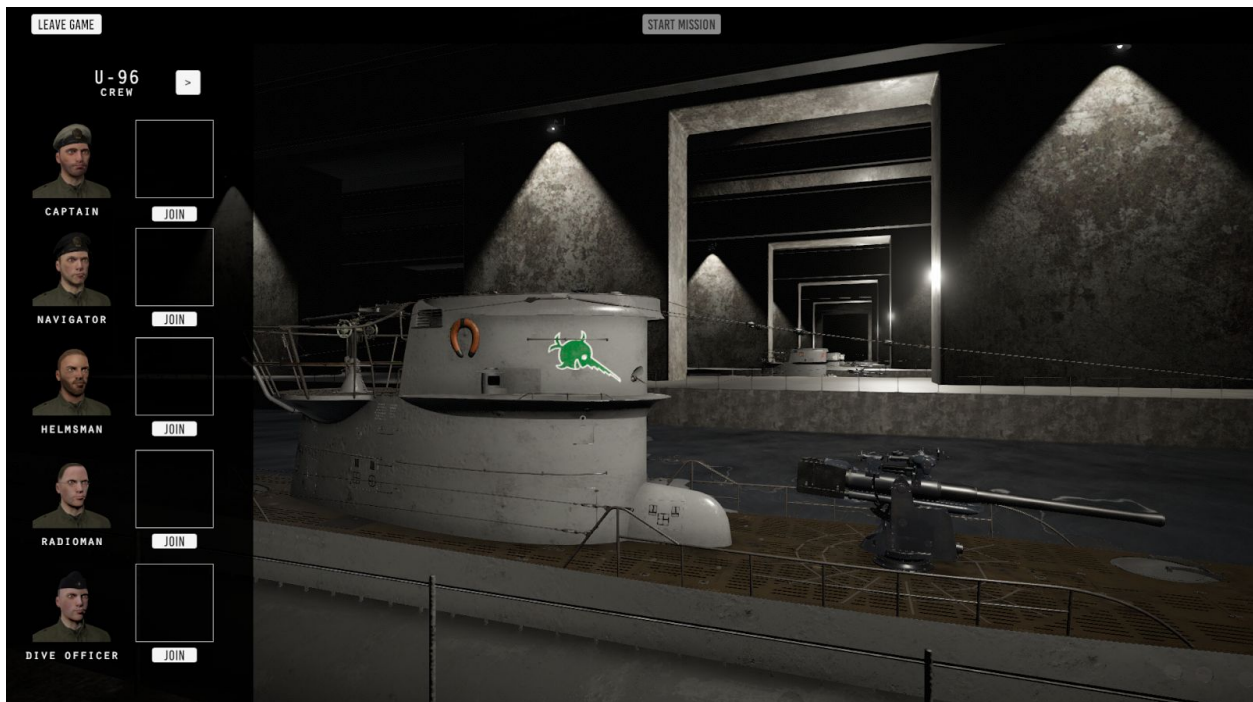

Basic controls

Use the W, A, S and D keys to walk around. Hold shift to sprint. To start using a station in the U-boat, left click it. To stop using the station, right click anywhere.

To climb ladders, left-click the ladder to grab it, press W to climb upwards and S to climb downwards. When climbing, left click the top hatch to open or close it. Right-click to slide down and stop using the ladder. To access the radio compartment, walk or run through the open hatch in the control room.

While outside, enter binocular mode by scrolling forward on the mouse scroll wheel. To stop using the binoculars, scroll backwards. Press M to toggle the map view. Press escape to open the menu. Press T to start and stop the timer. Press R to reset and hide the timer. Enable the flashlight by pressing F. Switch between red, green and white light by pressing G. Press C to bring up the mission window. Press and hold Q to display the objectives window.

Press enter to access the in-game chat. Type your message, and press enter again to send the message. In game chat messages only reach your crew. Press and hold Tab to view a list of the players in the session. You can change the key bindings and turn on tooltips in the options menu.

Overview

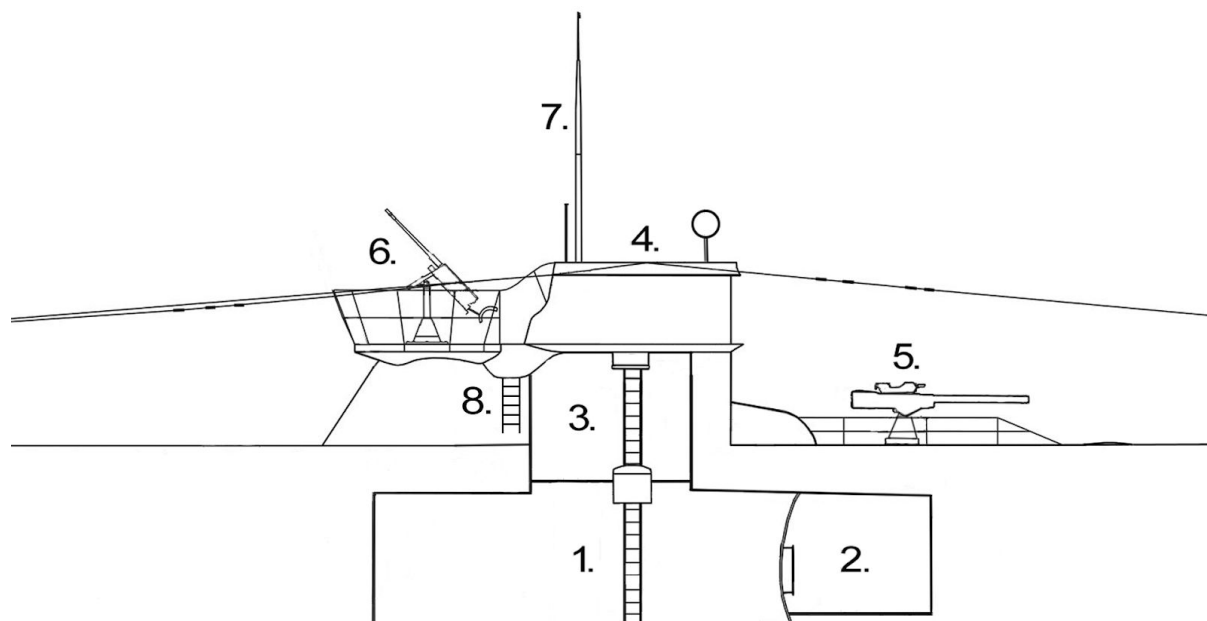

Outside section view.

1. Control room.
2. Radio room.
3. Conning tower.
4. Bridge.
5. Deck gun.
6. Anti-aircraft gun.
7. Periscope.
8. Ladder

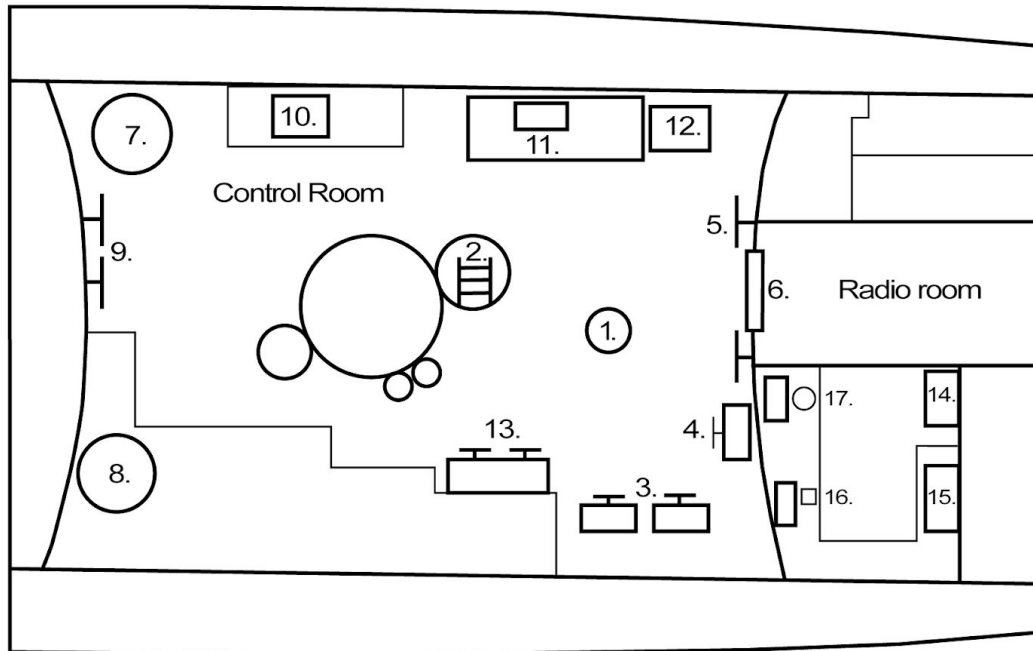

Top view of the control room and the radio room.

1. Observation periscope.
2. Ladder to conning tower.
3. Diving station.
4. Rudder controls.
5. Forward ballast vents.
6. Radio room hatch.
7. Compressor.
8. Bilge pump.
9. Aft ballast vents.
10. Echo ranger.
11. Odometer.
12. Periscope hoist mechanism.
13. Ballast and negative tank controls.
14. Hydrophone.
15. Record player.
16. Radio communication equipment.
17. Radio direction finder.

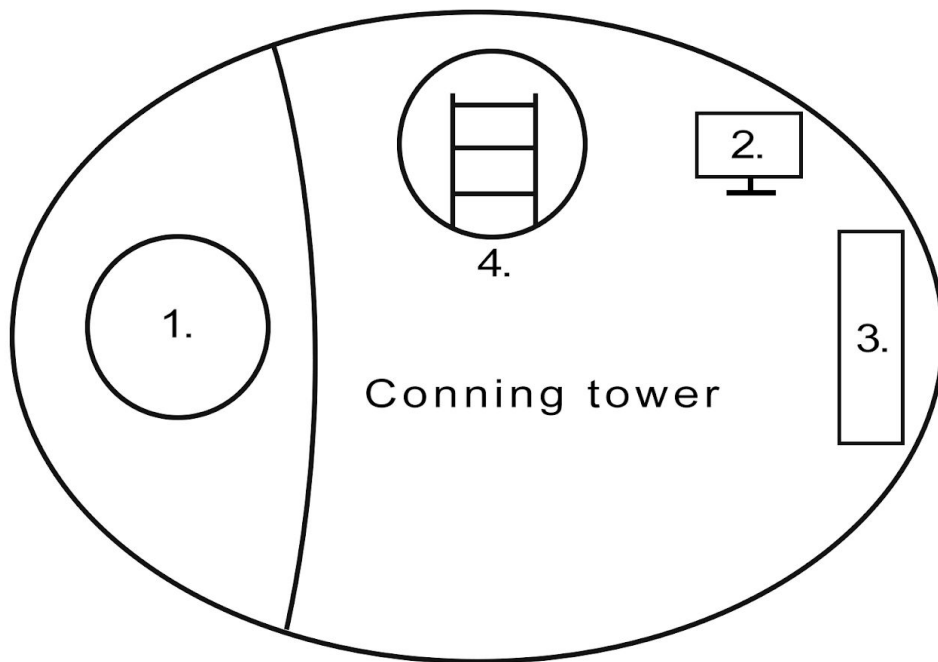

Top view of the conning tower.

- 1. Attack periscope.*
- 2. Rudder controls.*
- 3. Torpedo data computer.*
- 4. Ladder from control room to bridge.*

The Engine order telegraphs

An Engine Order Telegraph, or EOT, is used to send orders to the engine room. There are two sets of EOTs, one in the control room, and one in the conning tower. The left and right EOT represent the port and starboard engine, and can be operated independently of each other. Holding shift while clicking an order change will change both EOTs simultaneously.

The EOT can be used to set various speeds, forward and backward. A higher speed makes more noise, and uses more energy. While in electric mode, the u boat's battery reserves are drained while moving. The cost of moving increases quadratically with speed, so moving at a slow pace is much more efficient. If the u boat is surfaced, the diesel engines may be started. The diesel engines are faster, and can be used to charge the batteries.

To start charging, start the diesel engines, and select charge battery. The u boat will continue to charge until the diesels are turned off, or the battery is full. The faster the u boat moves, the slower it charges the batteries. If the u boat dives with the diesels still running, the diesels will flood.

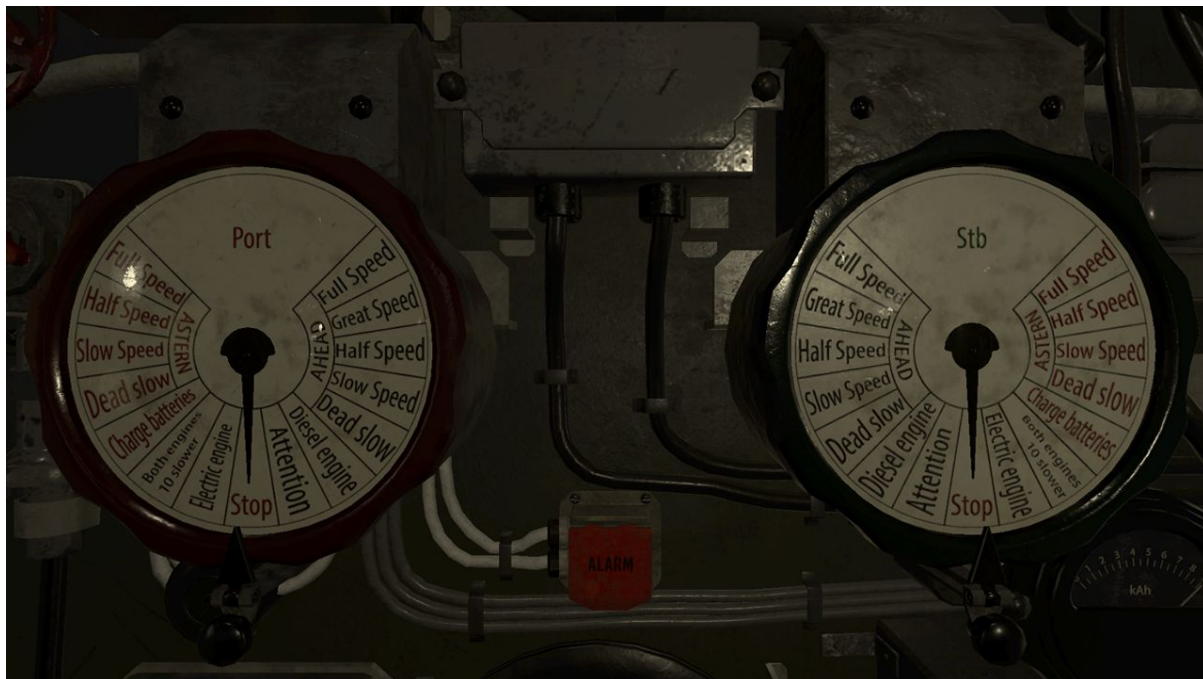

Use the EOT by clicking on it. The left and right EOT represent the port and starboard engine, and can be operated independently of each other. Holding shift while clicking an order change will change both EOTs simultaneously. Selecting the orders written in black makes the boat run forward and the red orders makes it run backward.

Rudder controls

The u boat has three rudder control stations. They are situated on the bridge, in the conning tower, and in the control room. To start steering, click the rudder. To steer left and right, use the A and D key. To move the rudder into a neutral position, press W. The rudder angle indicator to the right shows the resulting rudder angle.

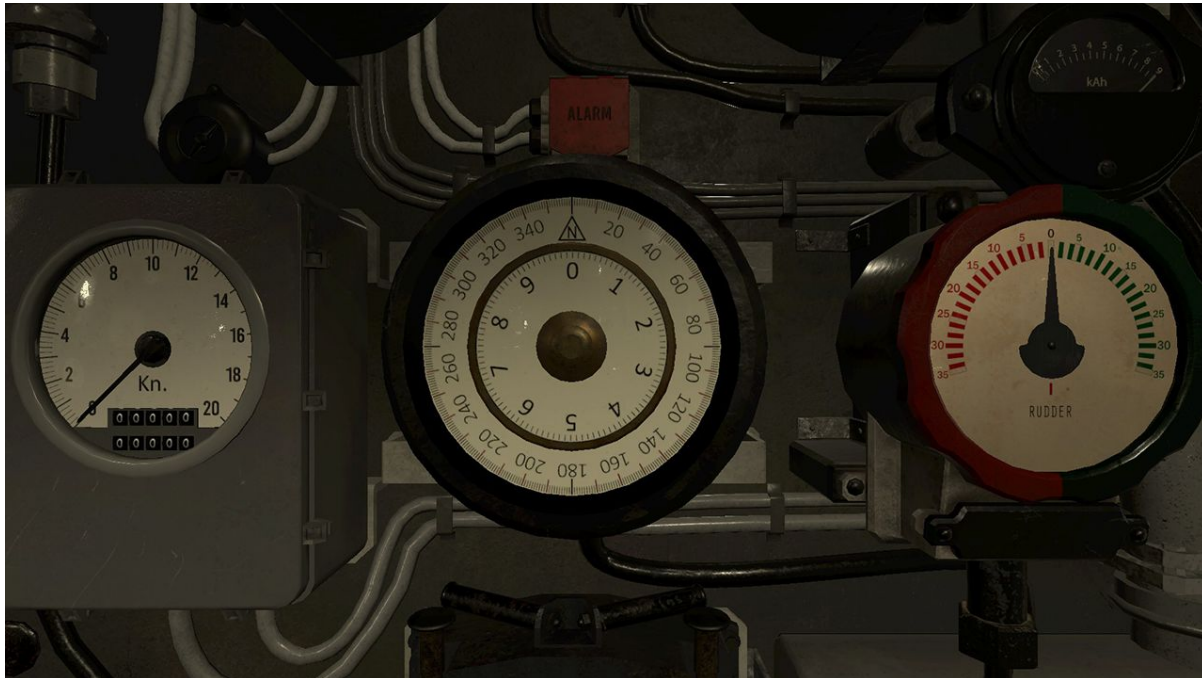

Use the A and D keys to steer left and right. Press W to move the rudder to a neutral position.

Diving and surfacing

A U-boat maintains its buoyancy by filling and emptying large water tanks. With the ballast tanks empty, the u boat has a positive buoyancy, and floats on the surface. With the ballast tanks flooded, the u boat will have a neutral buoyancy, and will maintain its current depth. To flood the forward and aft ballast tanks, open the ballast vents located in the front and back of the control room. Once the tanks have been flooded, it is good practice to close the vents.



The ballast vents are located in the front and back of the control room.

Before diving: Make sure the diesel engines are turned off, that the crew is safe inside the U-boat, and that the top hatch is closed.

When the U-boat is neutrally buoyant, it can change its depth using the dive planes. The dive planes are pairs of horizontal rudders located in the stern and bow. If the U-boat has forward momentum, the dive planes force the U-boat up or down depending on the tilt of the plane. The dive plane controls are located in the forward starboard side of the control room. The forward dive plane can be moved using the A and D buttons, and the aft diveplane can be moved using the left and right arrow keys. The U-boat's tilt is indicated by the tilt meter (blue liquid), and the depth is indicated by both the papenberg meter (red liquid), the fine depth meter (0-20 meter), and the coarse depth meter (0-200 meter).

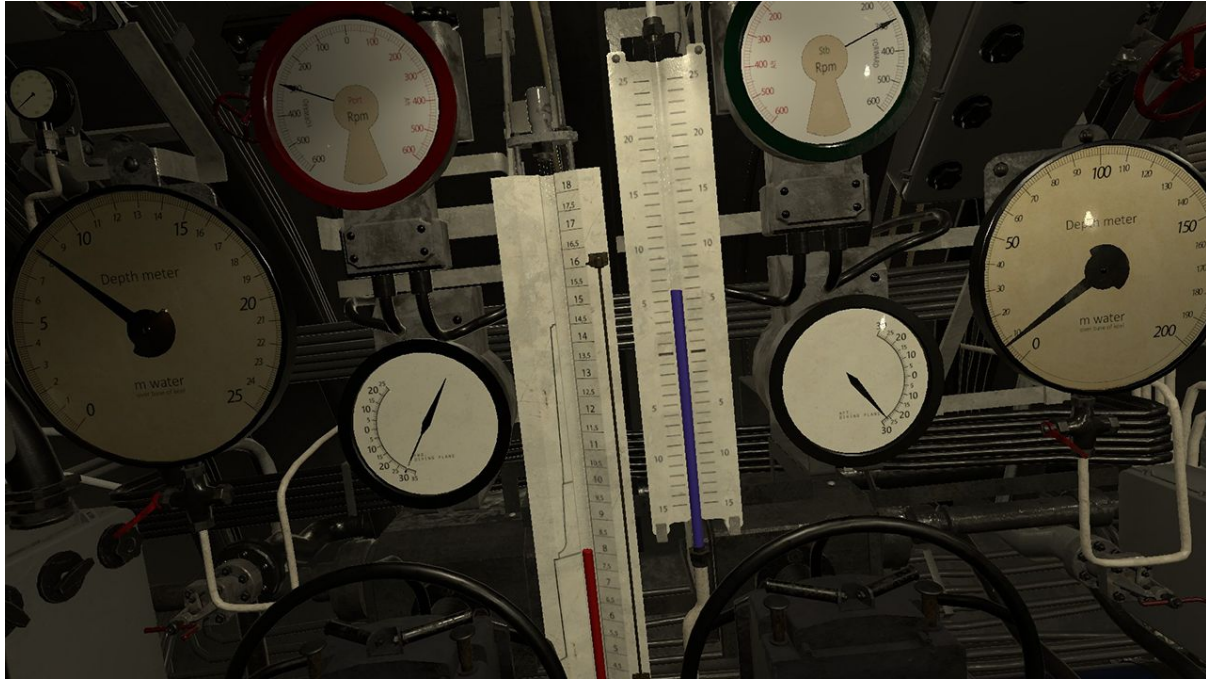

The forward dive plane can be moved using the A and D buttons, and the aft diveplane can be moved using the left and right arrow keys. The U-boats tilt is indicated by the tilt meter (blue liquid), and the depth is indicated by the papenberg meter (red liquid).

The U-boat can surface by blowing the ballast tanks using compressed air. The amount of compressed air required to blow the tanks is relative to the external water pressure. Water pressure increases with about 1 atmosphere with every 10 meters of depth. The tanks have a combined volume of 150 cubic meters, and require around 190 kg air per atmosphere of external pressure to be blown. The ballast tanks are blown using the ballast tank controls, located in the starboard side of the control room. Compressed air is shown by the dials at the ballast air controls, the negative tank controls, and on the bilge pump. To fill the compressed air, start the compressor while surfaced.



The ballast tanks are blown using the valve located in the starboard side of the control room. The water indicators, located over the ballast air control valve, will show how much water is in the tanks.

The U-boat is also equipped with a negative tank. The negative tank is small enough, so that if the negative is flooded, and the ballast is blown, the u boat still has positive buoyancy, and will float. If, however, both the ballast and negative tanks are flooded, the U-boat will rapidly sink. The negative tank is used for crash diving. Once the U-boat is below the surface, the negative tank should be blown, to keep the u boat from sinking. Both the negative tank vent and the negative tank air controls are located on the starboard side of the control room, next to the ballast tank air control.



The negative tank is used for crash diving. The negative tank vent is located on the starboard side of the control room.

The compressor and bilge pump

No U-boat is completely waterproof, and at a certain depth, the U-boat will start taking in water. The water will accumulate in the bilge, and will decrease the U-boats buoyancy by weighing it down. The water can be pumped out using the bilge pump. When below the surface, the pump replaces the water it pumps out of the bilge with compressed air from the air supply, so it needs to be carefully monitored. The bilge pump is located in the back left corner of the control room. Turn the red valve to start and stop the pump.



Water can be pumped out using the bilge pump.

The compressor is used to refill the U-boats air supply. It is located in the back right corner of the control room. It is started and stopped by turning the red handle. The compressor can not be started while under water.



The compressor.

Periscopes and the UZO

A type VII U-boat has two periscopes - the observation periscope and the attack periscope. The attack periscope is located in the conning tower. This periscope has a small head to avoid detection, and its optics are designed in such a way as to allow the periscope to be raised and lowered while using it. To raise and lower the attack periscope, press W or S respectively. To zoom in or out using the periscopes, use the mouse scroll wheel.



Attack periscope.

The observation periscope is located in the control room. It has a larger head to take in more light, and is shorter than the attack periscope. It can be raised or lowered using the periscope hoisting mechanism, located to the right of the map table, on the port side in the control room. The observation periscope's ocular is attached directly to the shaft, so it cannot be raised or lowered when used.



Periscope hoist mechanism.

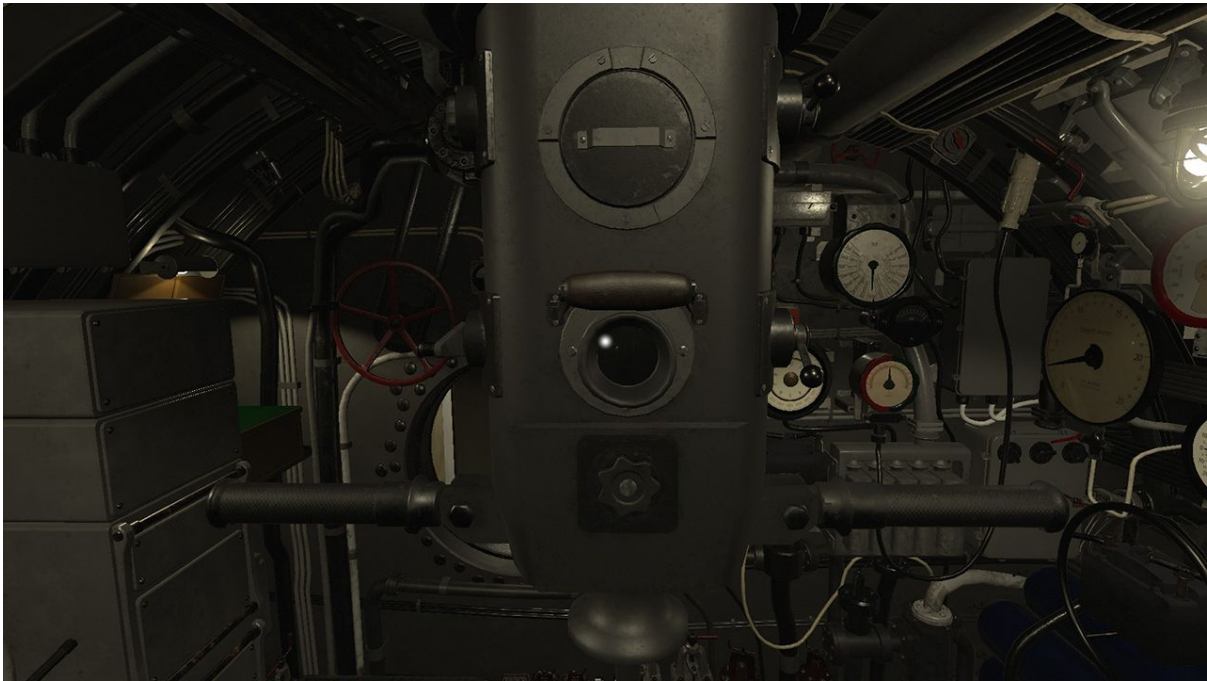

Observation periscope.

The periscopes measure the view angle in centiradians. 1 centiradian equals 1 meter seen from a distance of 100 meters. To calculate target distance, simply divide the target height (meters) by the view angle (centiradians). This gives you the distance to the target in hectometers, which is the scale used both in the torpedo data computer, and the deck gun sight. One hectometer is 100 meters.

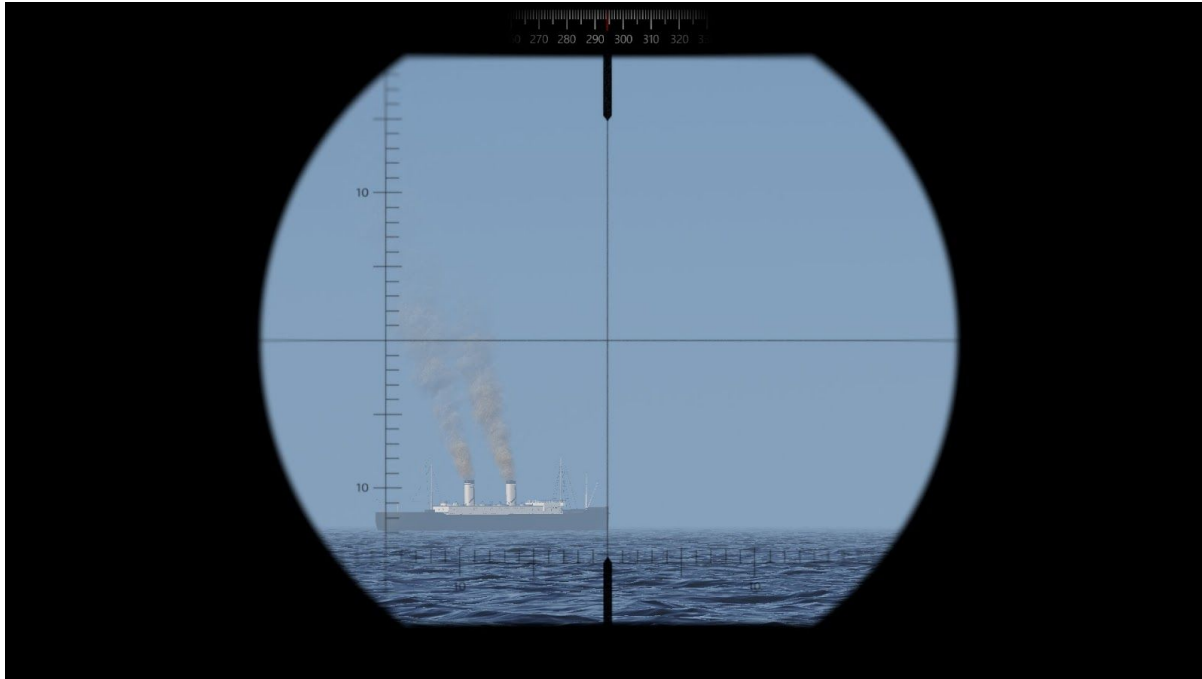

Ship observed through the observation periscope. The small horizontal and vertical lines represents centiradians. The length of the ship is 16 centiradians.

Both periscopes have a normal magnification level of 1.5x, and a high magnification level of 6x. To calculate the distance to the target when zoomed in, multiply the derived distance value by 4. You can also use the attack distance table by pressing "C" and clicking the distance table tab.

MISSION RECOGNITION MANUAL DISTANCE TABLE

Table for calculating attack distances

PERISCOPE ZOOM X1.5

CENTIRADIAN

	1	2	3	4	5	6	7	8	9	10	11	12	13	14	15	16	17	18	19	20
10	100	50	33	25	20	17	14	13	11	10	09	08	08	07	07	06	06	06	05	05
12	120	60	40	30	24	20	17	15	13	12	11	10	09	09	08	08	07	07	06	06
14	140	70	47	35	28	23	20	18	16	14	13	12	11	10	09	09	08	08	07	07
16	160	80	53	40	32	27	23	20	18	16	15	13	12	11	11	10	09	09	08	08
18	180	90	60	45	36	30	26	23	20	18	16	15	14	13	12	11	11	10	09	09
20	200	100	67	50	40	33	29	25	22	20	18	17	15	14	13	13	12	11	11	10
22	220	110	73	55	44	37	31	28	24	22	20	18	17	16	15	14	13	12	12	11
24	240	120	80	60	48	40	34	30	27	24	22	20	18	17	16	15	14	13	13	12
26	260	130	87	65	52	43	37	33	29	26	24	22	20	19	17	16	15	14	14	13
28	280	140	93	70	56	47	40	35	31	28	25	23	22	20	19	18	16	16	15	14
30	300	150	100	75	60	50	43	38	33	30	27	25	23	21	20	19	18	17	16	15
32	320	160	107	80	64	53	46	40	36	32	29	27	25	23	21	20	19	18	17	16
34	340	170	113	85	68	57	49	43	38	34	31	28	26	24	23	21	20	19	18	17
36	360	180	120	90	72	60	51	45	40	36	33	30	28	26	24	23	21	20	19	18
38	380	190	127	95	76	63	54	48	42	38	35	32	29	27	25	24	22	21	20	19
40	400	200	133	100	80	67	57	50	44	40	36	33	31	29	27	25	24	22	21	20
45	450	225	150	113	90	75	64	56	50	45	41	38	35	32	30	28	26	25	24	23
50	500	250	167	125	100	83	71	63	56	50	45	42	38	36	33	31	29	28	26	25
55	550	275	183	138	110	92	79	69	61	55	50	46	42	39	37	34	32	31	29	28
60	600	300	200	150	120	100	86	75	67	60	55	50	46	43	40	38	35	33	32	30
65	650	325	217	163	130	108	93	81	72	65	59	54	50	46	43	41	38	36	34	33
70	700	350	233	175	140	117	100	88	78	70	64	58	54	50	47	44	41	39	37	35
75	750	375	250	188	150	125	107	94	83	75	68	63	58	54	50	47	44	42	39	38
80	800	400	267	200	160	133	114	100	89	80	73	67	62	57	53	50	47	44	42	40
85	850	425	283	213	170	142	121	106	94	85	77	71	65	61	57	53	50	47	45	43
90	900	450	300	225	180	150	129	113	100	90	82	75	69	64	60	56	53	50	47	45
100	1000	500	333	250	200	167	143	125	111	100	91	83	77	71	67	63	59	56	53	50
110	1100	550	367	275	220	183	157	138	122	110	100	92	85	79	73	69	65	61	58	55
120	1200	600	400	300	240	200	171	150	133	120	109	100	92	86	80	75	71	67	63	60
130	1300	650	433	325	260	217	186	163	144	130	118	108	100	93	87	81	76	72	68	65
150	1500	750	500	375	300	250	214	188	167	150	136	125	115	107	100	94	88	83	79	75

PERISCOPE ZOOM X6.0

CENTIRADIAN

	1	2	3	4	5	6	7	8	9	10	11	12	13	14	15	16	17	18	19	20
10	400	200	133	100	80	67	57	50	44	40	36	33	31	29	27	25	24	22	21	20
12	480	240	160	120	96	80	69	60	53	48	44	40	37	34	32	30	28	27	25	24
14	560	280	187	140	112	93	80	70	62	56	51	47	43	40	37	35	33	31	29	28
16	640	320	213	160	128	107	91	80	71	64	58	53	49	46	43	40	38	36	34	32
18	720	360	240	180	144	120	103	90	80	72	65	60	55	51	48	45	42	40	38	36
20	800	400	267	200	160	133	114	100	89	80	73	67	62	57	53	50	47	44	42	40
22	880	440	293	220	176	147	126	110	98	88	80	73	68	63	59	55	52	49	46	44
24	960	480	320	240	192	160	137	120	107	96	87	80	74	69	64	60	56	53	51	48
26	1040	520	347	260	208	173	149	130	116	104	95	87	80	74	69	65	61	58	55	52
28	1120	560	373	280	224	187	160	140	124	112	102	93	86	80	75	70	66	62	59	56
30	1200	600	400	300	240	200	171	150	133	120	109	100	92	86	80	75	71	67	63	60
32	1280	640	427	320	256	213	183	160	142	128	116	107	98	91	85	80	75	71	67	64
34	1360	680	453	340	272	227	194	170	151	136	124	113	105	97	91	85	80	76	72	68
36	1440	720	480	360	288	240	206	180	160	144	131	120	111	103	96	90	85	80	76	72
38	1520	760	507	380	304	253	217	190	169	152	138	127	117	109	101	95	89	84	80	76
40	1600	800	533	400	320	267	229	200	178	160	145	133	123	114	107	100	94	89	84	80
45	1800	900	600	450	360	300	257	225	200	180	164	150	138	129	120	113	106	100	95	90
50	2000	1000	667	500	400	333	286	250	222	200	182	167	154	143	133	125	118	111	105	100
55	2200	1100	733	550	440	367	314	275	244	220	200	183	169	157	147	138	129	122	116	110
60	2400	1200	800	600	480	400	343	300	267	240	218	200	185	171	160	150	141	133	126	120
65	2600	1300	867	650	520	433	371	325	289	260	236	217	200	186	173	163	153	144	137	130
70	2800	1400	933	700	560	467	400	350	311	280	255	233	215	200	187	175	165	156	147	140
75	3000	1500	1000	750	600	500	429	375	333	300	273	250	231	214	200	188	176	167	158	150
80	3200	1600	1067	800	640	533	457	400	356	320	291	267	246	229	213	200	188	178	168	160
85	3400	1700	1133	850	680	567	486	425	378	340	309	283	262	243	227	213	200	189	179	170
90	3600	1800	1200	900	720	600	514	450	400	360	327	300	277	257	240	225	212	200	189	180
100	4000	2000	1333	1000	800	667	571	500	444	400	364	333	308	286	267	250	235	222	211	200
110	4400	2200	1467	1100	880	733	629	550	489	440	400	367	338	314	293	275	259	244	232	220
120	4800	2400	1600	1200	960	800	686	600	533	480	436	400	369	343	320	300	282	267	253	240
130	5200	2600	1733	1300	1040	867	743	650	578	520	473	433	400	371	347	325	306	289	274	260
150	6000	3000	2000	1500	1200	1000	857	750	667	600	545	500	462	429	400	375	353	333	316	300

Distance table. Make sure to use the correct table for the periscope zoom level you are using.

For example:

A 30 meter tall mast will take up 3 centiradians in your scope if the ship is at a distance of 10 hectometers (1000 meters) at the normal zoom level, 40 hectometers (4 km) at the high zoom level.

Target speed can be calculated by dividing the length of the target by the amount of time it takes for the target to pass the vertical line in the crosshair when the u boat is stationary. This will give you the target speed in meters per second. 1 meter per second is 1.94 knots, so multiplying this value by two gives you a good speed estimate.



The UZO is located on the bridge.

The UZO (Underwasserzieloptik) is a simple targeting system used for quick surface attacks. The UZO is essentially a pair of binoculars mounted on a pedestal on the bridge. The pedestal contains a selsyn link that transmits the pedestal rotation to the U-boats torpedo data computer, and a trigger for firing torpedoes. The UZO has no range finder, and no zoom.

Recognition manual

To calculate the distance to a ship, you need to know the ship's mast height or length. This information can be obtained by finding the ship in the recognition manual. Access the manual by pressing "C". Open the "Merchants" tab and enter the features of the observed ship in order to find it.

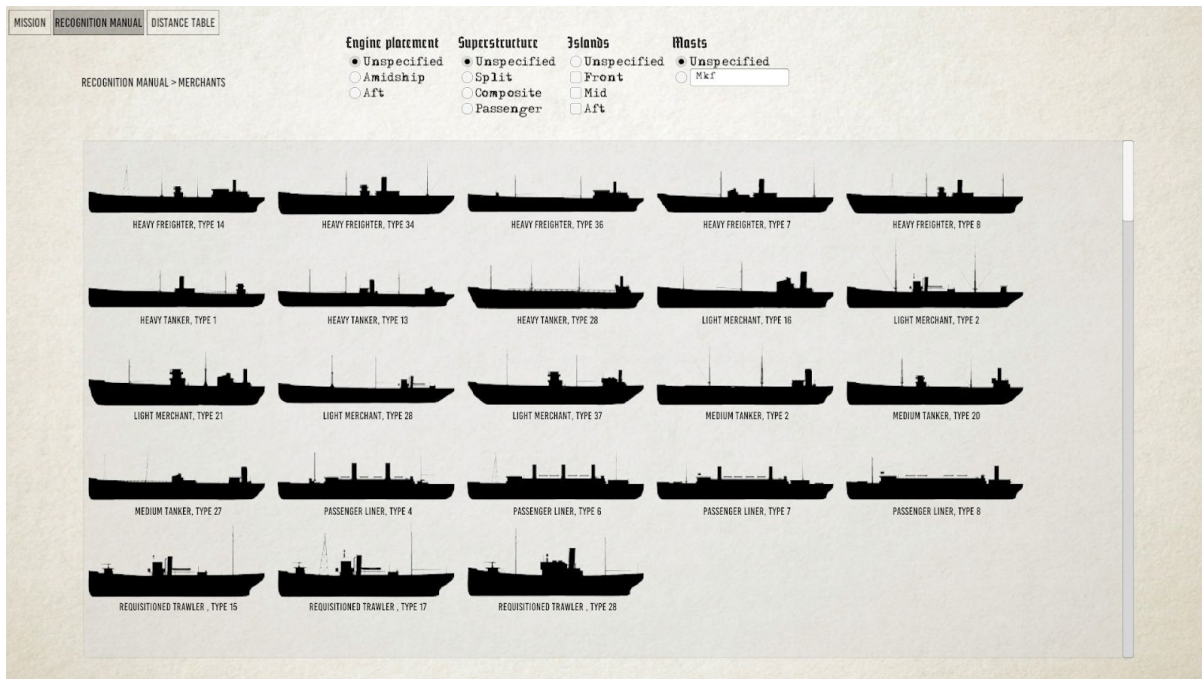

Merchants tab.

Ships are identified by their engine placement, their superstructure, their hull type, and mast combination. The engine is placed either at the back or middle of the ship, and can be easily identified by the placement of the smoke stack.

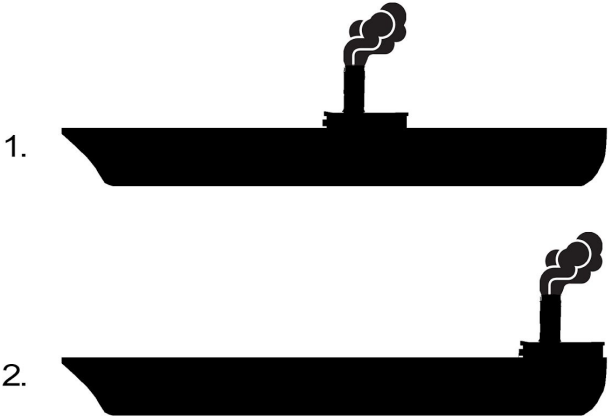

Engine placement. 1. Amidship. 2. Aft.

The ship's superstructure can be of three different types: Composite, split and passenger type. Composite structures are continuous structures no longer than $\frac{1}{3}$ of the the ship's total length. If the structure is longer, or if the ship has more than one smoke stack, the ship is to be coded as passenger type. If the superstructure is not continuous, it is coded as split.

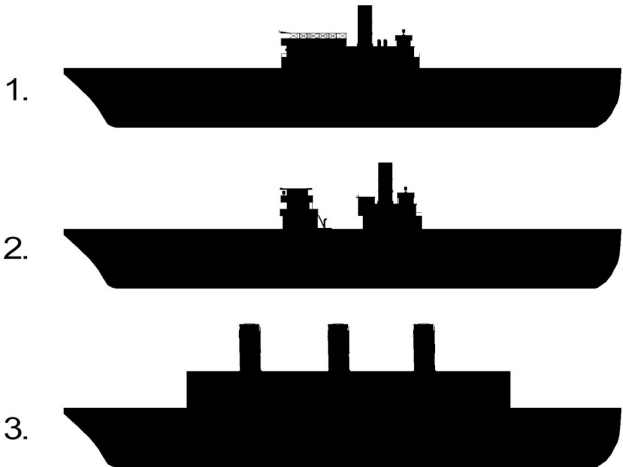

Superstructure. 1. Composite. 2. Split. 3. Passenger type.

Hull type, or island arrangement, is based on the presence or absence of full deck height structures above the main deck. These may occur at the vessel's forecastle, or aft, or amidships, or may not appear at all, in which event the hull is considered flush. It is important to note that only such structures as extend to the full width of a vessel's hull are considered island, others being regarded as deck houses and are not used as a basis for type selection.



Hull type. 1. Flush. 2. Front. 3. Mid. 4. Aft.

Mast combinations are coded front to aft. Kingposts, masts and funnels are coded in the order they appear, by the letters K, M and F, respectively. A kingpost is a type of crane consisting of two vertical masts parallel to each other with two "spars" attached to them in a 90 degree angle. Any mastlike structure that is not a kingpost is to be coded as a mast. Smoke stacks are to be coded as funnels.

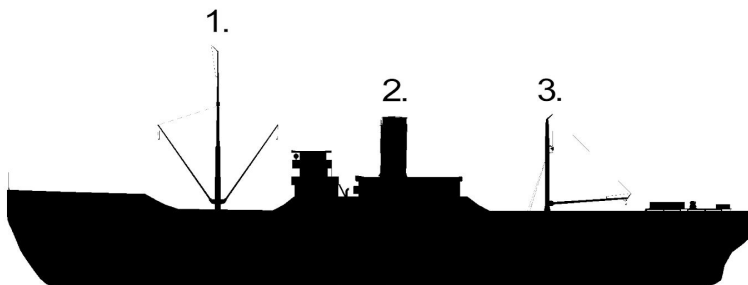

Masts, Kingposts and funnels. 1. Mast. 2. Funnel. 3. Kingpost. The correct input for the ship depicted above would be "MFK", where "M" represents the mast, "F" the funnel and "K" the kingpost. The order of the input must always be done from the ship's bow to its stern.

Examples

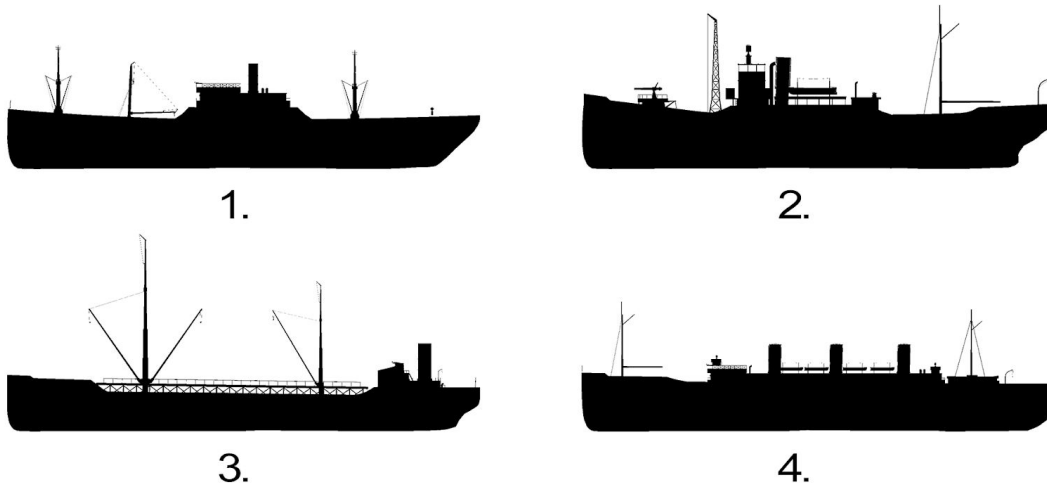

Examples of combinations.

- 1: Engine placement: **Amidship**, Superstructure: **Composite**, Islands: **Mid**, Masts: **MKFM**
- 2: Engine placement: **Amidship**, Superstructure: **Composite**, Islands: **Mid, Aft**, Masts: **MFM**
- 3: Engine placement: **Aft**, Superstructure: **Composite**, Islands: **Front, Aft**, Masts: **MMF**
- 4: Engine placement: **Amidship**, Superstructure: **Passenger type**, Islands: **Front, Mid**, Masts: **MFFF**

When you find the ship you are looking for, left-click it to view it's specific information.

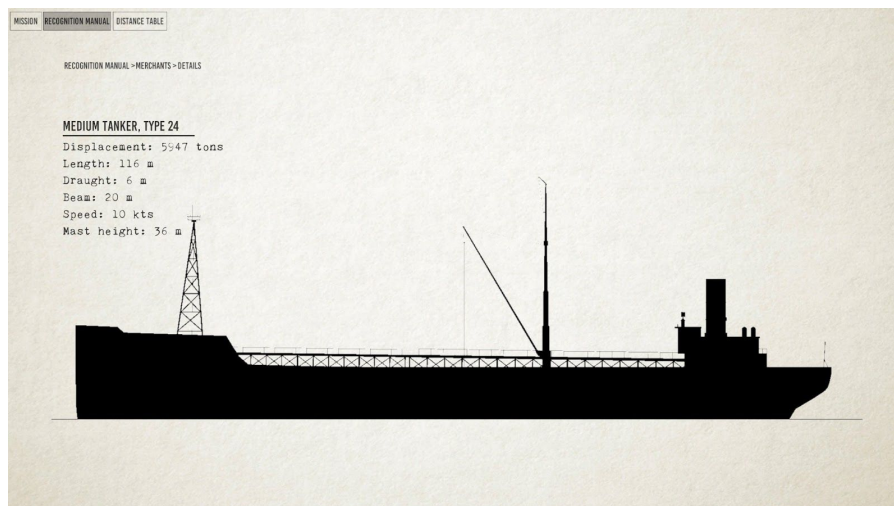

The specific information page.

The TDC

The type VII U-boat uses a torpedo data computer (TDC), to calculate torpedo firing trajectories. The TDC is located in the conning tower, next to the ladder. To calculate the trajectory, target distance, target speed, heading and angle on bow must be known. The angle on the bow is the angle between target course and target bearing.

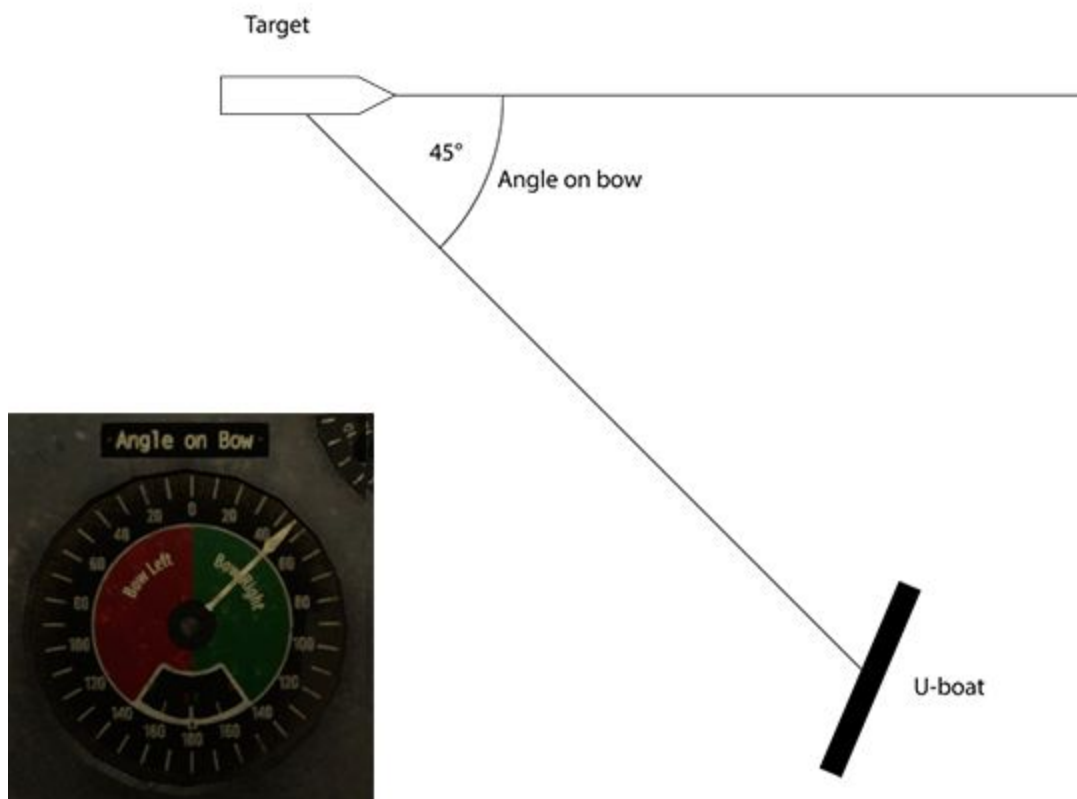

If the U-boat is 45 degrees to the right of the target, then the AOB is 45 degrees right. Bow right means that the target is traveling from left to right, from the U-boat's perspective.

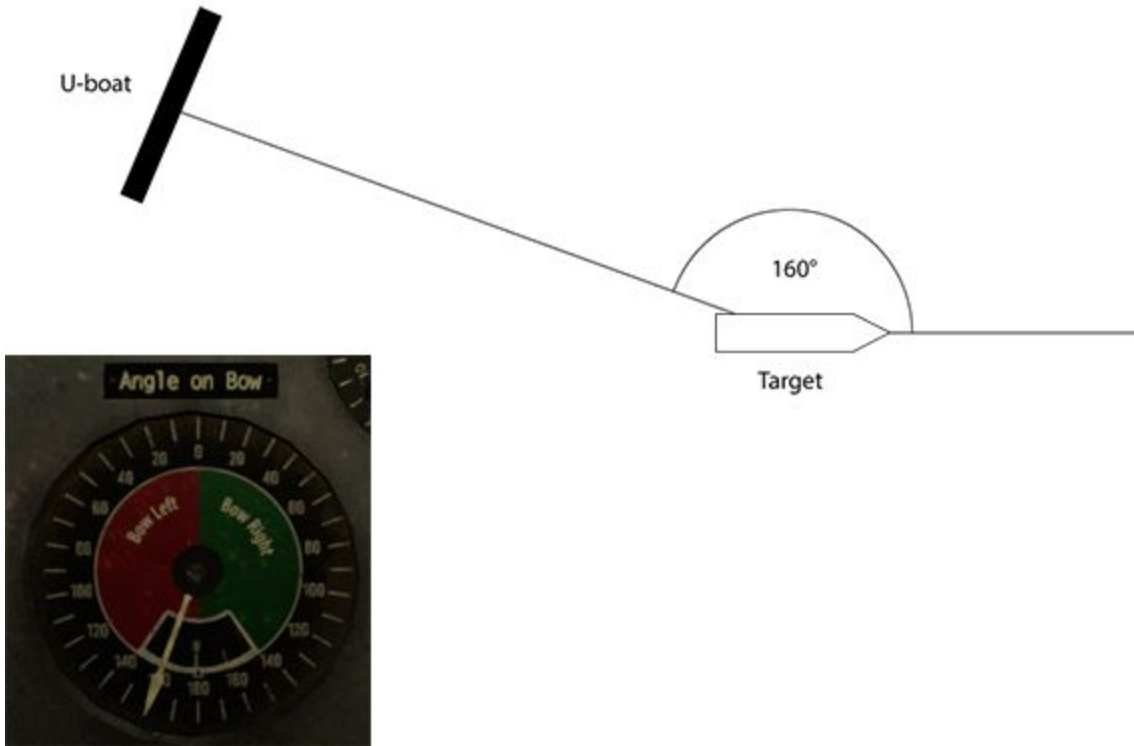

If the AOB is greater than 90 degrees, the target is moving away from the U-boat.



The torpedo data computer is located in the conning tower.

1. **Target speed.** Set the estimated speed of the ship you are targeting.
2. **Torpedo depth.** Set the torpedoes running depth.
3. **Range.** Set the estimated distance to the target ship.
4. **Angle on bow.** Set the direction in which the ship is traveling relative to your viewpoint.
5. **Length.** Set the estimated length of the target ship.
6. **Torpedo status display.** The lights indicates if the corresponding a torpedo tube is ready for launch.
7. **Angle tracking device.** Select your aiming device by turning the handle.
8. **Torpedo tube selection.** Turn the handle to select your desired torpedo tube for launch.
9. **Salvo shot selection.** Choose which torpedo tubes to use in a salvo shot.
10. **Timer.** The timer displays the torpedoes estimated travel time.
11. **Error light.** If the lamp turns red, the entered firing solution is invalid.

Launching a single torpedo

To fire a torpedo, first use one of the periscopes to find the target distance and speed (see the periscopes section above). Enter these values into the TDC. On the TDC, select your aiming device using the angle tracking selector. This will slave the heading to the periscope rotation. While aiming at the center of the target, enter the angle on the bow. The AOB is automatically updated when the heading value changes, but the distance value is not. When firing at several

targets traveling in the same direction, only the distance value needs to be updated between shots.

Select which torpedo tube to fire from using the single shot selector. Tube 1-4 are forward torpedo tubes, tube 5 is the aft tube. The torpedo status panel will let you know which tubes are loaded. Before launching, set torpedo running depth using the depth selector, a lower hit will be more damaging.

Pressing space while using the tracked device (in this case the periscope) will launch the torpedo. If the angle tracking is set to off, torpedoes may be launched from the TDC station by pressing space.

The red error light will light up if the target is out of range, if the U-boat is too deep to fire a torpedo, or if the gyro angle requires the torpedo to turn more than ± 135 degrees.

Launching a salvo

To fire a salvo shot, input all the settings required to fire a single shot, and input the target length using the length selector. Select salvo in the tube selector. Using the salvo shot selector, select which tubes you want to fire.

The deck gun

The deck gun is located on the forward deck. You can reach the forward deck by climbing down the right or left ladder from the bridge. Left click to equip it. Use the A and D keys, or the mouse to rotate left and right. Use the W and S keys, or the scroll wheel to set the target distance. Setting the target distance allows you to aim straight at the target and hit it without over or undershooting.

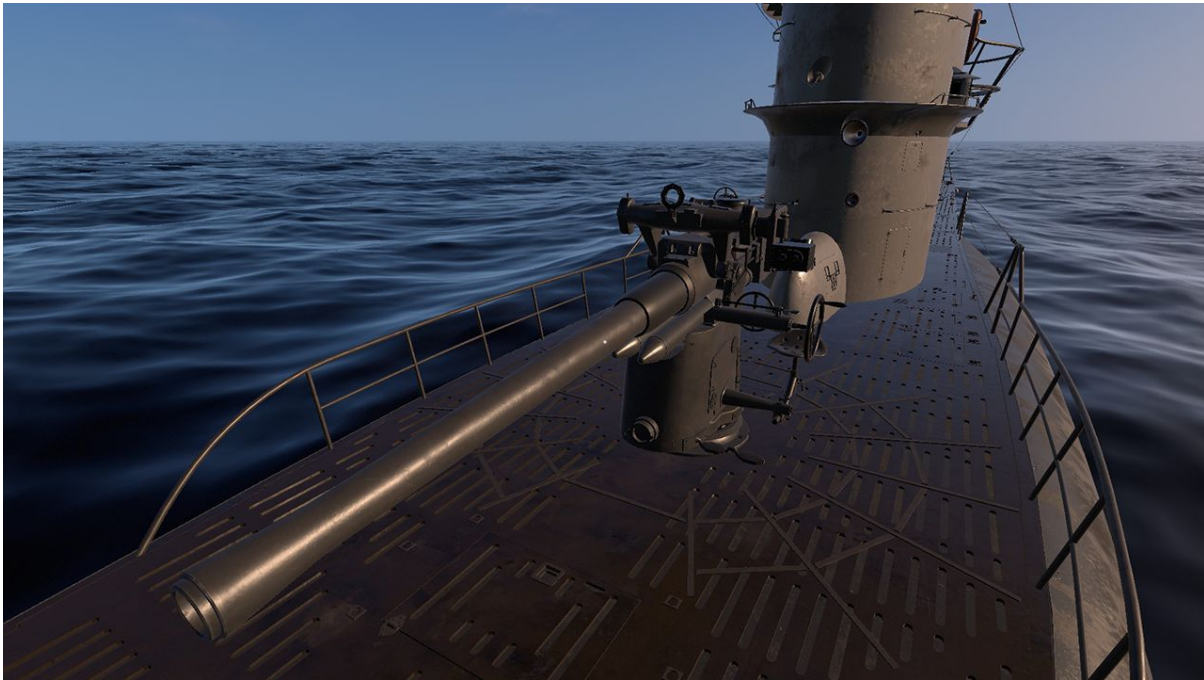

The deck gun is located on the forward deck. You reach the forward deck by climbing down the right or left ladder from the bridge.



Deck gun sight view. Use the w and s keys, or the scroll wheel to set the target distance. The distance is in hectometers.

The anti aircraft gun

The anti aircraft gun is located in the crow's nest on the bridge. Left click to equip it. Use space, or the left mouse button to fire. Right click to stop using it.

The AA gun projectiles use ballistic trajectories and have a travel time, so you need to aim slightly higher, and lead the target in order to hit.



The AA-gun is located in the crow's nest on the bridge.

The radio transceiver

The radio transceiver is located above the enigma machine in the radio compartment. Turn the left knob to set the receiving channel, and the right knob to set the broadcasting channel. Use the Morse key located on the table below the radio to send the message. To send while using the morse key, simply type the letter you wish to send on the keyboard.



Communication radio.

The Enigma machine



Enigma machine and Morse key.

The Enigma machine is a device used to encrypt and decrypt radio messages. The Enigma uses a system of mechanical switches connected to rotating code wheels. The signal is then passed through a switchboard, before being passed to the top of the machine. The encryption key can be set by rotating the wheels located on the top of the device. The correct switchboard combination is already set when the game is started.

When a key is pressed, the corresponding cypher letter is lit on the top of the machine, and the encryption wheels rotate. This means that typing the same letter many times in a row will result in a seemingly random output pattern. This is what gives the Enigma its strength as an encryption device. The cipher is symmetrical, meaning that if a particular encryption key results in K being translated to F, then the same setting will translate F to K. To decrypt a message, the receiver simply needs to type in the ciphertext, and the output should be the plain text that the sender encoded, provided that both the sending and receiving machines use the same key settings.

Since the receiver must know what encryption key was used to send it, and the key changes as the message is typed, the message must always be preceded by the start encryption settings in plain text, followed by the encrypted message. This, however, presents a problem, as if the enemy has captured a machine, and has made the correct switchboard adjustments to it, they

can decrypt the message. To avoid this, two encryption keys must be chosen: One public key, and one secret key. The public key is sent in plain text, and is used to encrypt the secret key. The secret key is then used to encrypt the rest of the message.

For example:

I want to send the encrypted message "HELLO THERE". I choose a random public key: "PKJ", and a random secret key: "GWP". I first write down the public key in plain text: PKJ, then I set the encryption wheels to PKJ and type my secret key GWP on the keyboard. This gives me the output UFI. I write that down. I then set the encryption wheels to GWP, and type HELLO THERE, writing down the output. I can now send the message, which should look like this:

PKJ UFI FIKDX QBLQB.

When the receiving u boat picks up the message, the radio operator sets their encryption wheels to PKJ, and then type in UFI, which gives them the secret key GWP. They then use that key to decrypt the rest of the message.

Remember to never use a public key that can be used to guess the secret key, for example public: BER and secret: LIN.

The radio direction finder

A radio direction finder is a device used for finding the direction of a radio source. The type VII U-boat uses a circular antenna located on the bridge of the U-boat, which can be rotated in order to determine the direction of the radio source. The diameter of the circle is the same as the length of the typical short radio wave. This means that when a radio wave hits the antenna from the side, it picks up the wave just like a normal aerial, but if the antenna is rotated so that it faces the source, both sides of the antenna are hit at the same time, causing phase cancellation and silence.

The direction finder controls are located on the desk next to the enigma machine. Use the band knob to choose which band you want to scan. Use the frequency dial to scan through the band. Adjust the volume using the volume dial. Use the compass plate mounted on the desk in front of the direction finder to rotate the antenna. When the signal becomes silent, the antenna is aligned with the wave. Remember that, since the antenna is symmetrical, the source may be at the 0, or at the 180 degree mark.

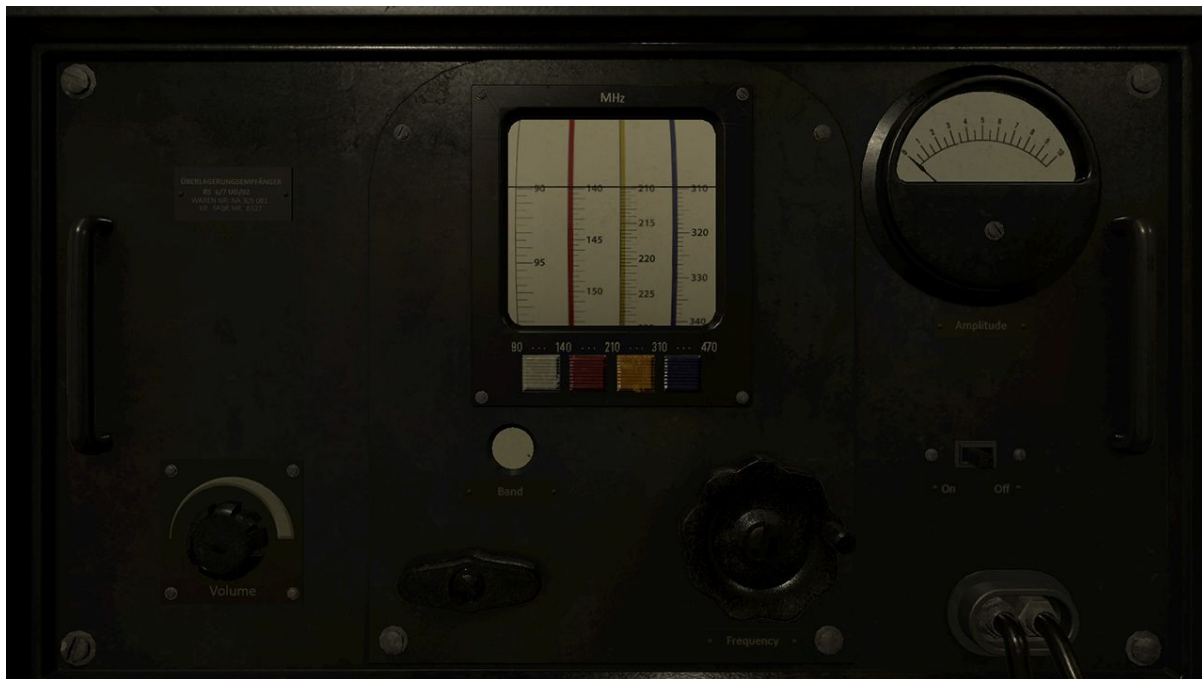

Radio direction finder.



Use the compass plate mounted on the desk in front of the direction finder to adjust the angle of the antenna until the signal becomes silent. Remember that since the antenna is symmetrical, the source may be at the 0, or at the 180 degree mark.

Record player

Click the record player to enter the record player mode. Use the switchboard on the left to enable the speakers in the different compartments. Use the volume knobs to adjust the volume. Click the record to access the track menu. Click a track to play it.



The record player is located in the radio room. Use the switchboard to enable the desired speakers and adjust the volume.

The echo ranger

The echo ranger is a device used for measuring the current distance from the U-boats keel to the seabed. It is located on the wall next to the compressor in the control room. Use the switch to toggle between long or short range. Press the button to measure the depth.

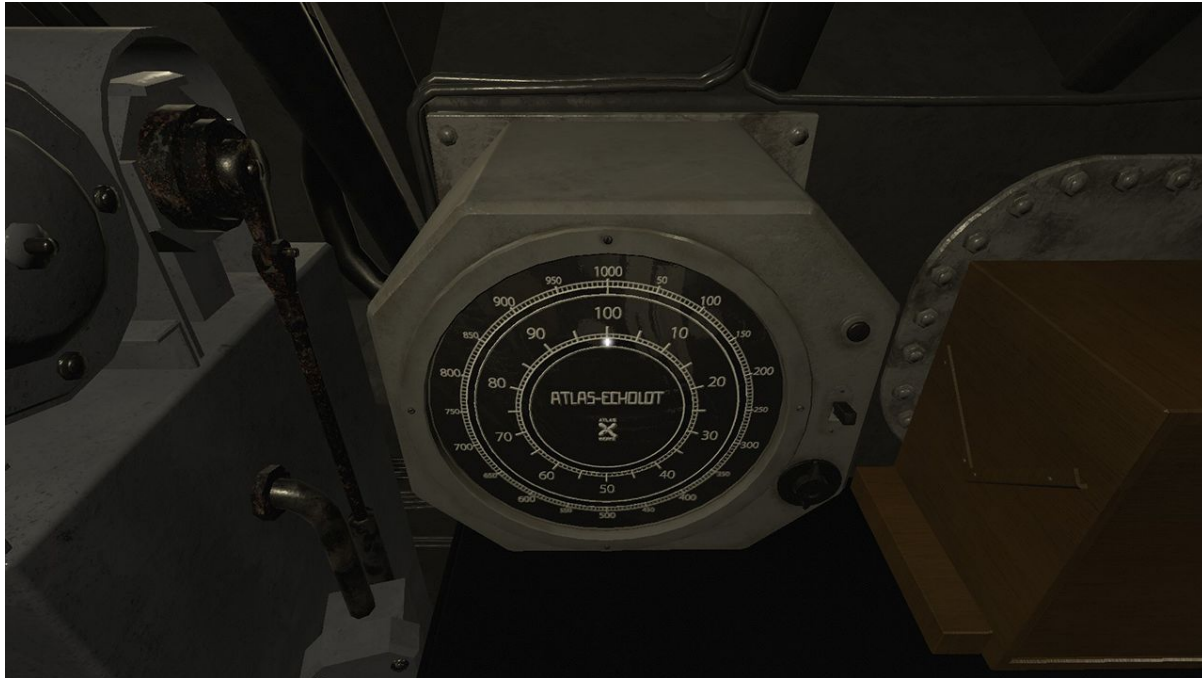

The echo ranger.

The map

The map view is accessed by pressing the 'm' key, or using the map table in the control room. When using the navigation table, you also have access to the ship's rotation, speed, and odometer.

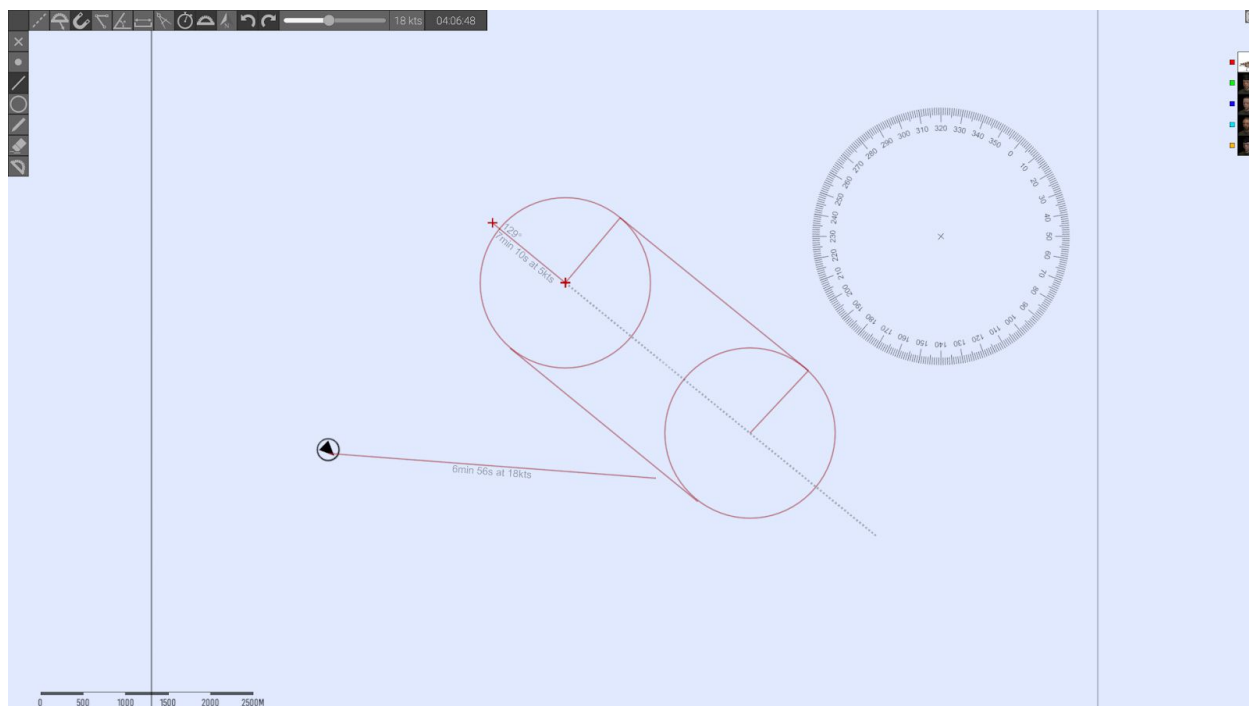

Everything drawn on the map can be seen by the other players in your crew. Each player has a map layer, with a corresponding color. You can only draw and erase on your own layer. The layers can be toggled on and off with the portrait buttons to the right in the image. Dotted lines are sketch lines, and are not shared with the other players.

The position of the U-boat is visible on the map until you dive, at which point the symbol turns gray, and the position is no longer updated. Other ships, torpedoes, etc, are not visible on the map.

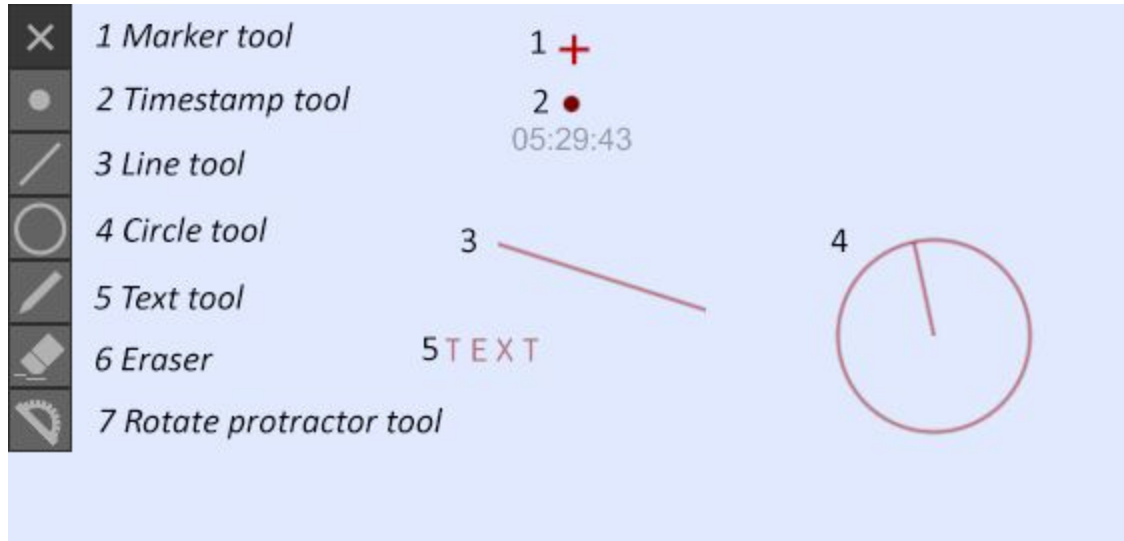

The toolbar to the left contain draw tools. Lines and circles can be drawn to an exact length and angle by inputting the desired value on the keypad while drawing. To draw a line of a specific length: Select the draw line tool. Click where you want the line to start. Enter the length on the keypad. Press the keypad enter key. Enter the desired angle, and press enter again.

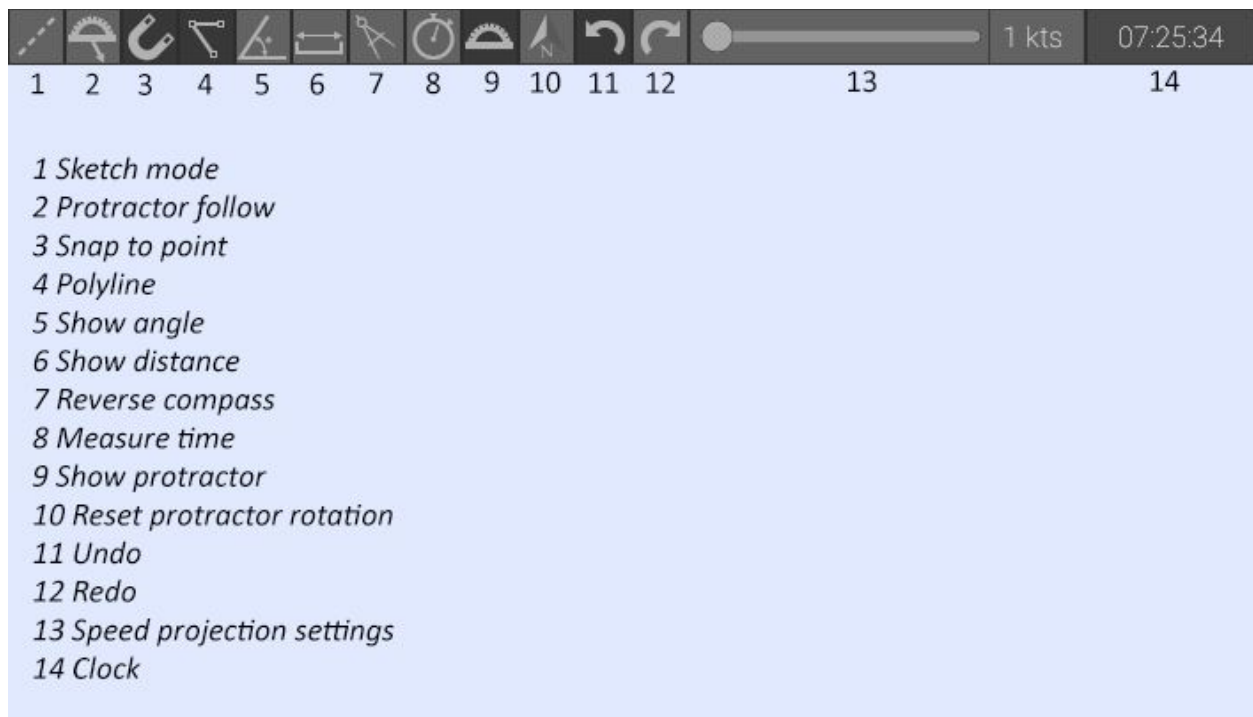

The tools in the top toolbar are toggle buttons that affect the behaviour of each draw tool.

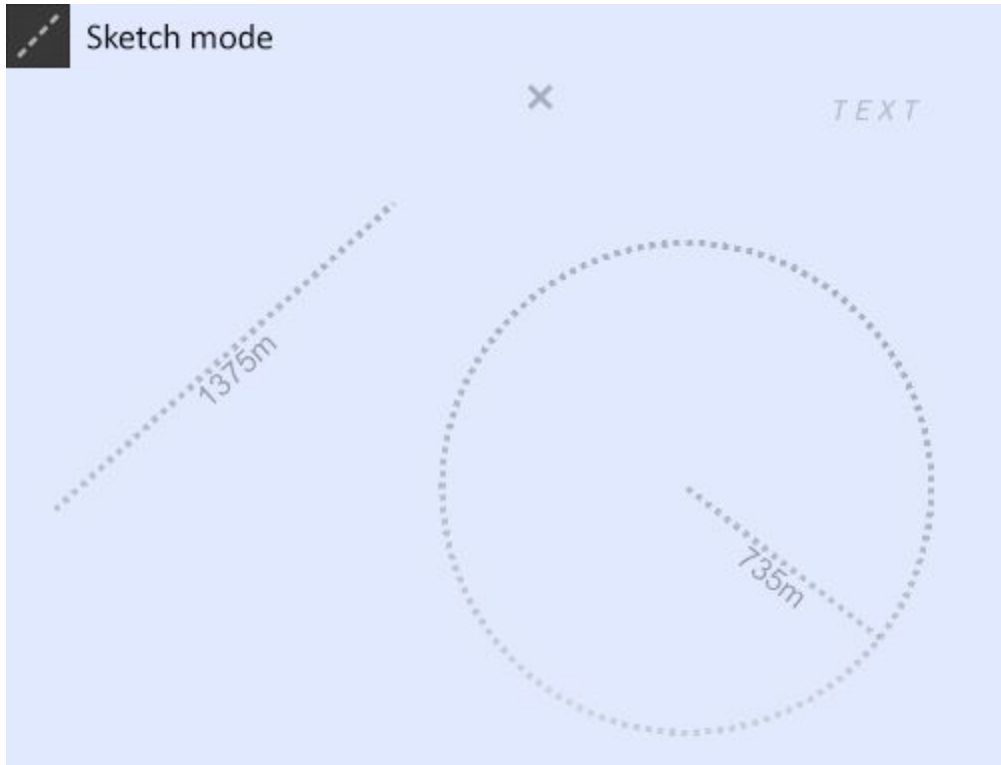

In sketch mode, lines and circles are dotted, and are not seen by the other players.

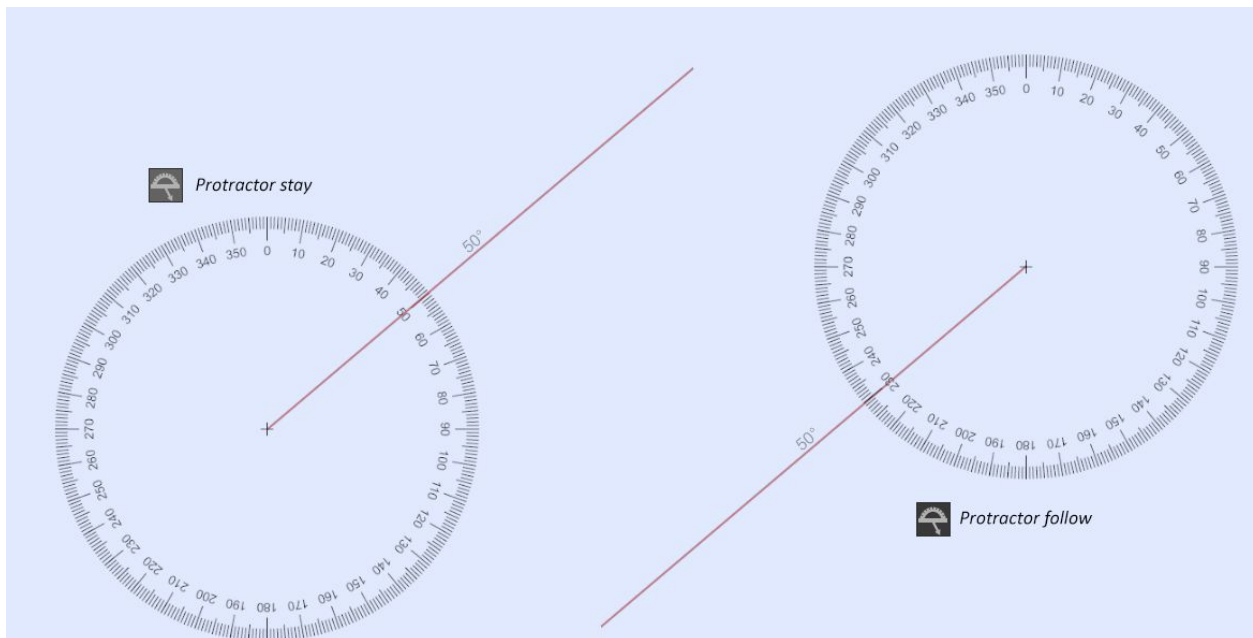

If protractor follow is on, the protractor always follows the mouse cursor. If it is off, the protractor stays when you start drawing the line.



Snap mode snaps the cursor to nearby lines or points.

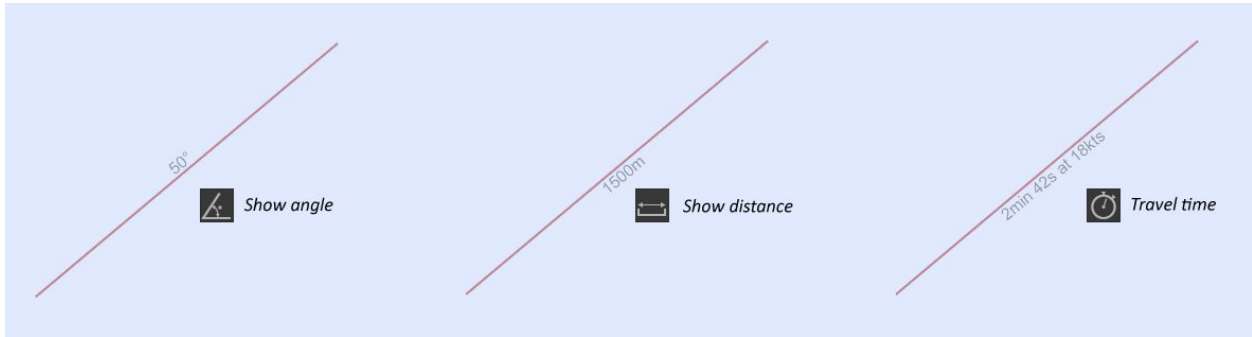

Show angle displays the angle of a drawn line. This does not affect lines that are already drawn, it only affects lines you draw after this is turned on. This information is shared with the other players. This is also true of the show distance, and travel time toggles. The point of this is that lines can mean different things in different contexts.

For example, the point of drawing a line might be to plot a course, in which case showing travel time and angles is a good idea. A line drawn by the sonar operator can mean the angle of a sonar observation. In this case, not showing the distance (because it is an unknown factor) is good practice.



In reverse compass mode circles are drawn starting with the edge instead of the center.



The measure time tool shows the time it would take to travel the length of a line at a certain speed. The speed can be changed with the slider, or by pressing the + and - keys on the keypad. This is useful for planning intercepts and plotting courses.



Show protractor toggles showing the protractor when drawing lines.



The reset protractor button resets the protractor rotation to compass north.



The undo and redo buttons undoes and redoes drawing and erasing.

Underwater navigation

When submerged, the position of the U-boat is not updated on the map. It is the navigator's job to update the position manually. When accessing the map through the map table, the navigator's tools become available.

12.3 kts	24°	20 m	31 m	000
1	2	3	4	5
<i>1 Speed</i>				
<i>2 Heading</i>				
<i>3 Current odometer value</i>				
<i>4 Last odometer value</i>				
<i>5 Reset odometer button</i>				

These show the current speed, heading and odometer settings. The odometer can also be reset using the reset odometer button.

10.3 kts	24°	2 m	348 m	000
<i>Last odometer value.</i>				
<i>This is the distance we have travelled since resetting the odometer.</i>				

When the U-boat dives, the navigator should reset the odometer. Now the left hand value that is being updated is the distance travelled since we submerged. After a few minutes, when it is time to update the U-boat's position on the map, the navigator resets the odometer again. The last odometer value is saved.

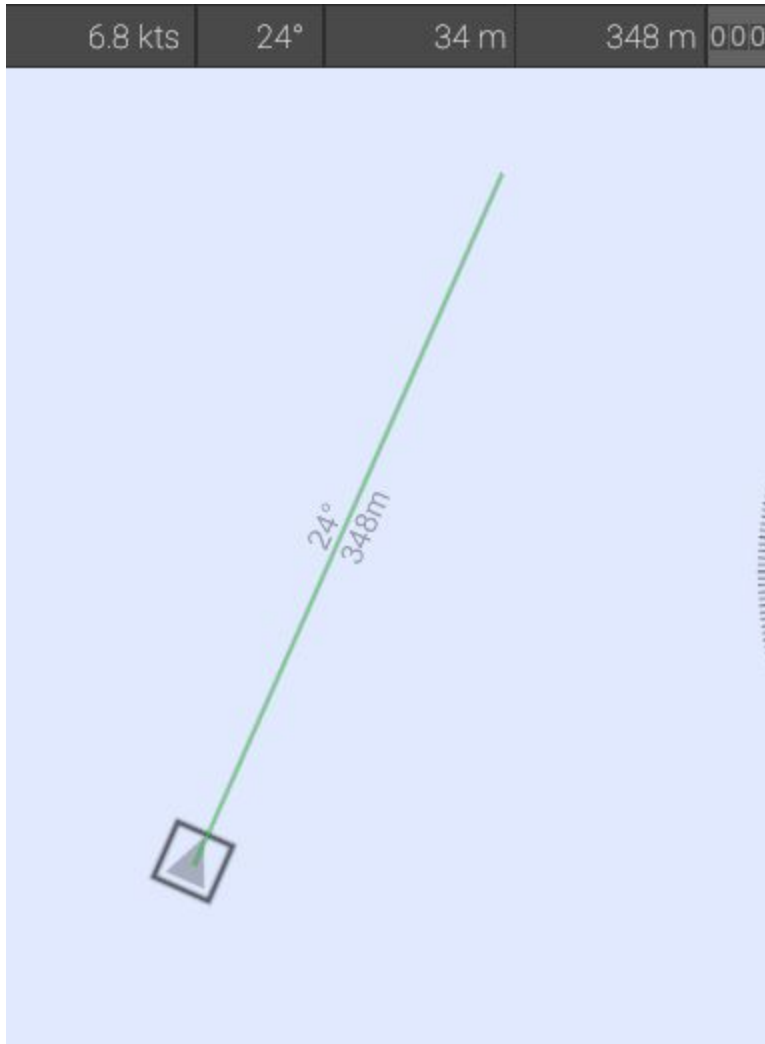

The navigator can now draw a line from the last known position, using the current heading and the distance read from the odometer.

This information will of course only be correct if the U-boat has not changed course since the last update. Before and after each course change, the odometer must be reset and the position updated. The navigator's job is made easier if the helmsman calls out when he starts and stops turning.

The hydrophone station

A hydrophone is a submersible microphone designed to pick up underwater sound. The U-boat is equipped with a hydrophone mounted on a rotating shaft. The hydrophone operator can determine the location of a sound source by rotating the shaft until the sound is the loudest. A skilled hydrophone operator can determine the distance, size and speed of a surface vessel just by listening through the hydrophone. When surfaced, the hydrophone is above the water line, and can not be used to detect enemy ships.

To adjust the direction of the hydrophone, rotate the wheel. Adjust volume, gain and filters by turning the respective knobs.

The noise made by the U-boats engines affect the hydrophone, making it harder to use while traveling at higher speeds.



Hydrophone.

To determine the course and speed of a ship, the hydrophone operator should note the direction that the sound source is coming from on the map with regular intervals.

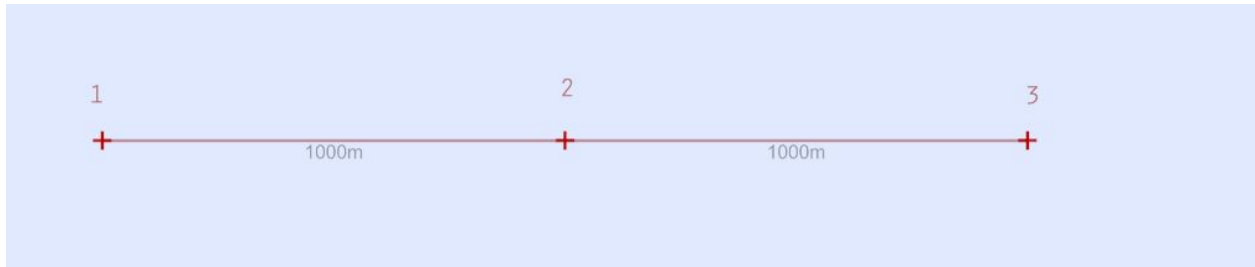

If a ship is moving at a constant speed, the distance the ship has travelled between the observations will be the same.

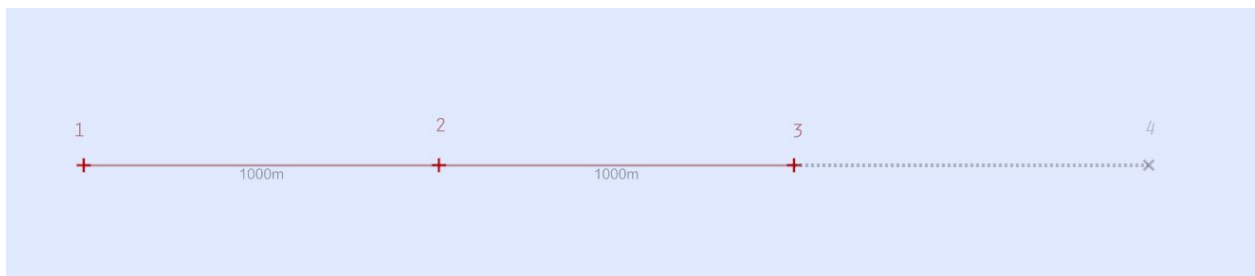

If the course of the ship is also unchanged, the course and position of the ship can be calculated by making four observations with regular intervals.

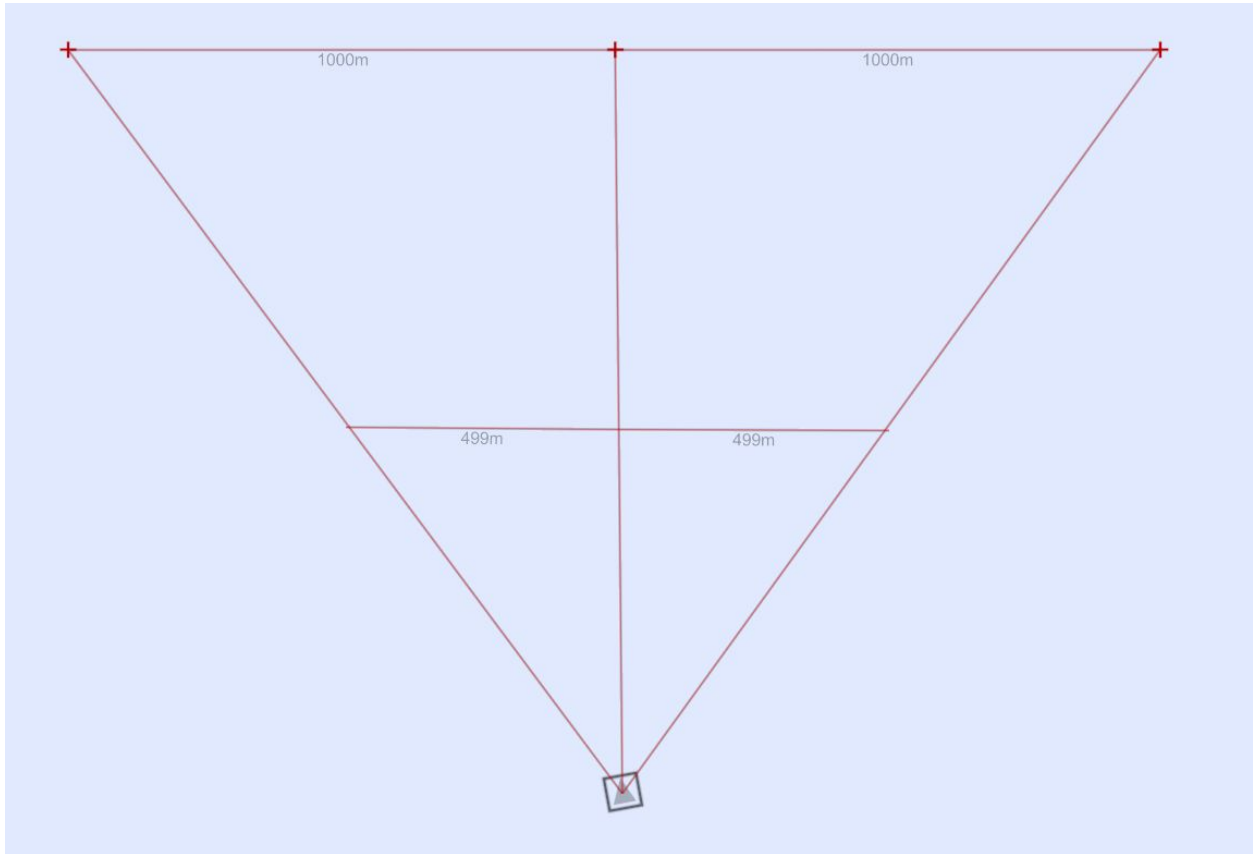

If we draw our observations of the ship on the map, the angle between observations will remain constant if the ship is traveling parallel to us.

If the ship is approaching, the angle between the observations will increase with time, and if the ship is receding, the angle between observations will decrease over time.

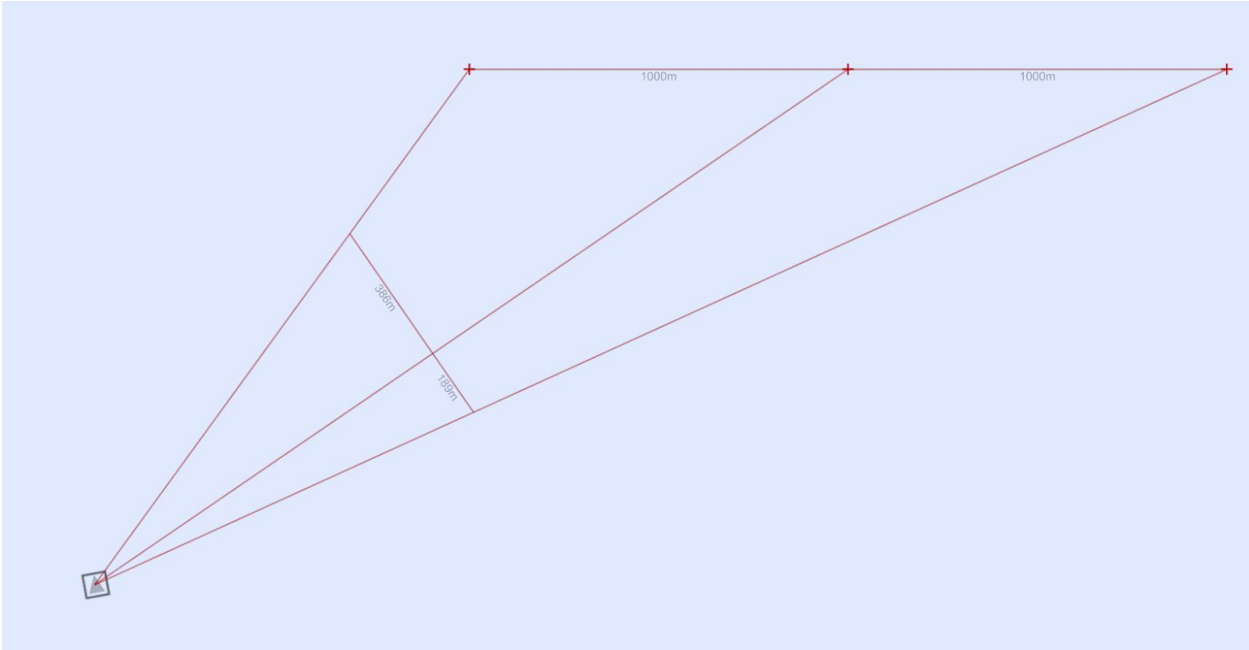

To estimate the course of the ship, draw a line from the first observation to the last observation, such that each line segment is of equal length.

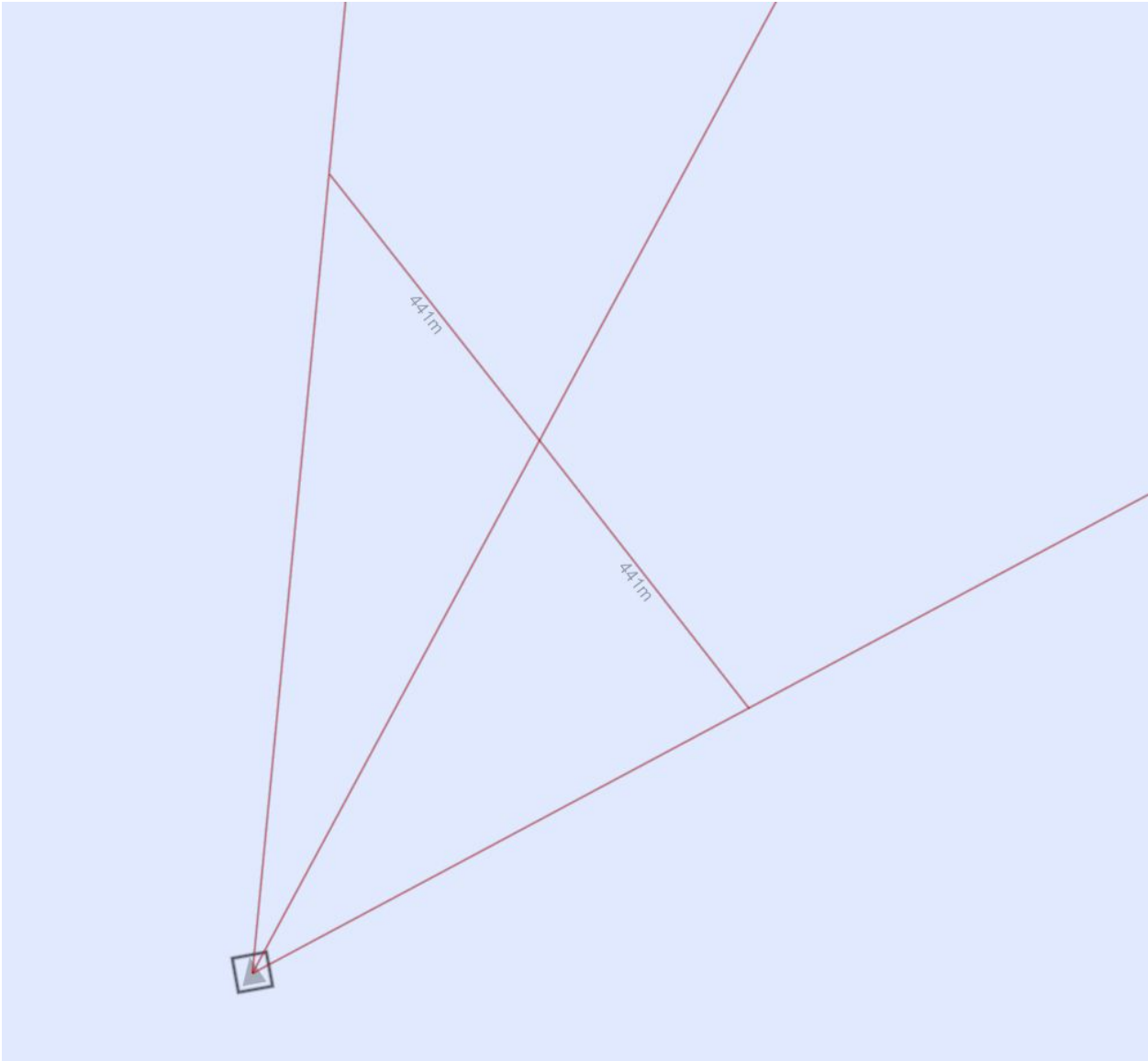

This is easily done by drawing a line from the first to the last observation line, such that the angle marker is exactly on the center observation line.

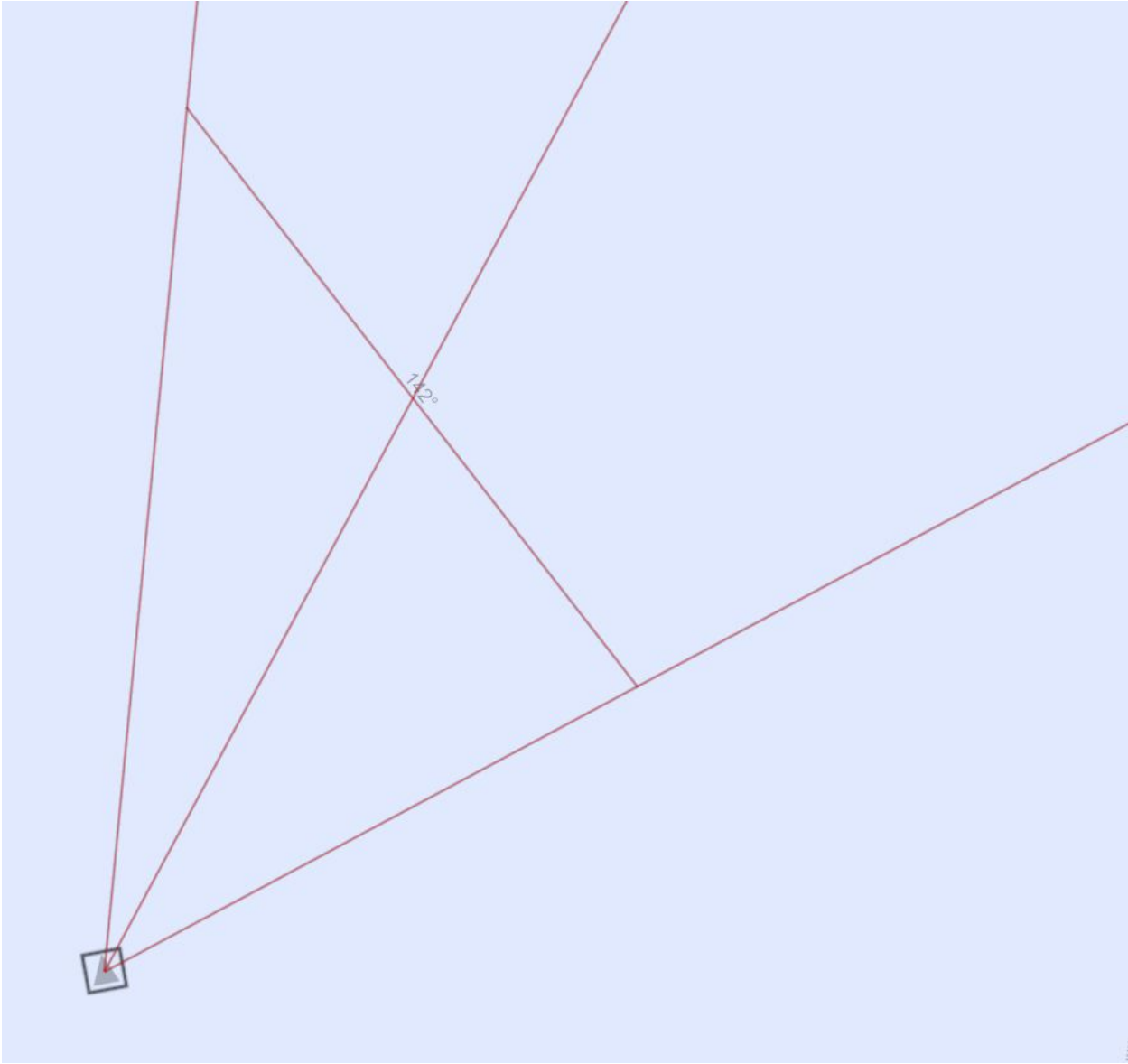

You now know the course of the ship, but not the distance to it.

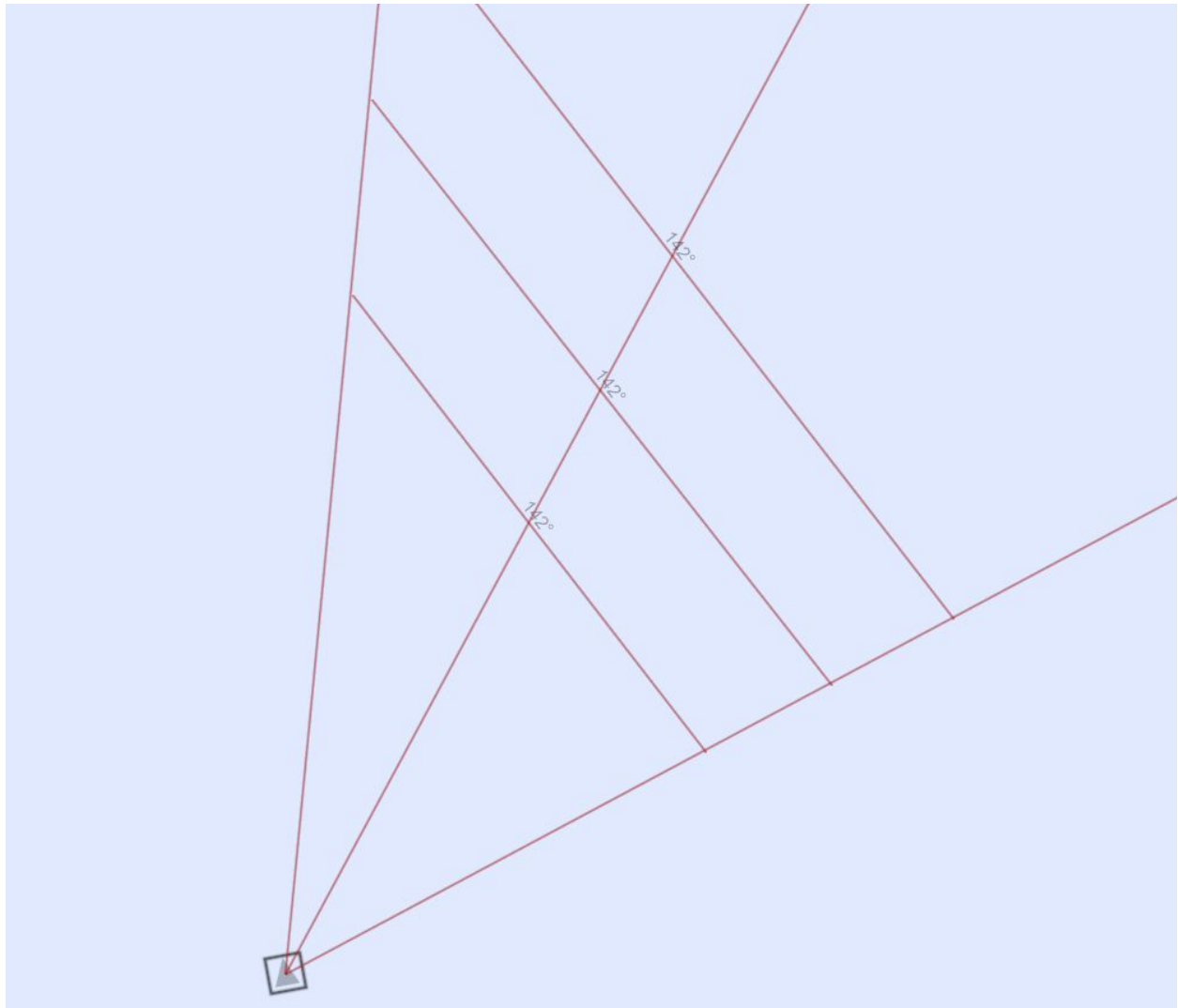

To triangulate the ship's position, we need to make an observation from a new vantage point. Since we know the ship's course, we can calculate the next observation angle by extrapolating from the last observation we made.

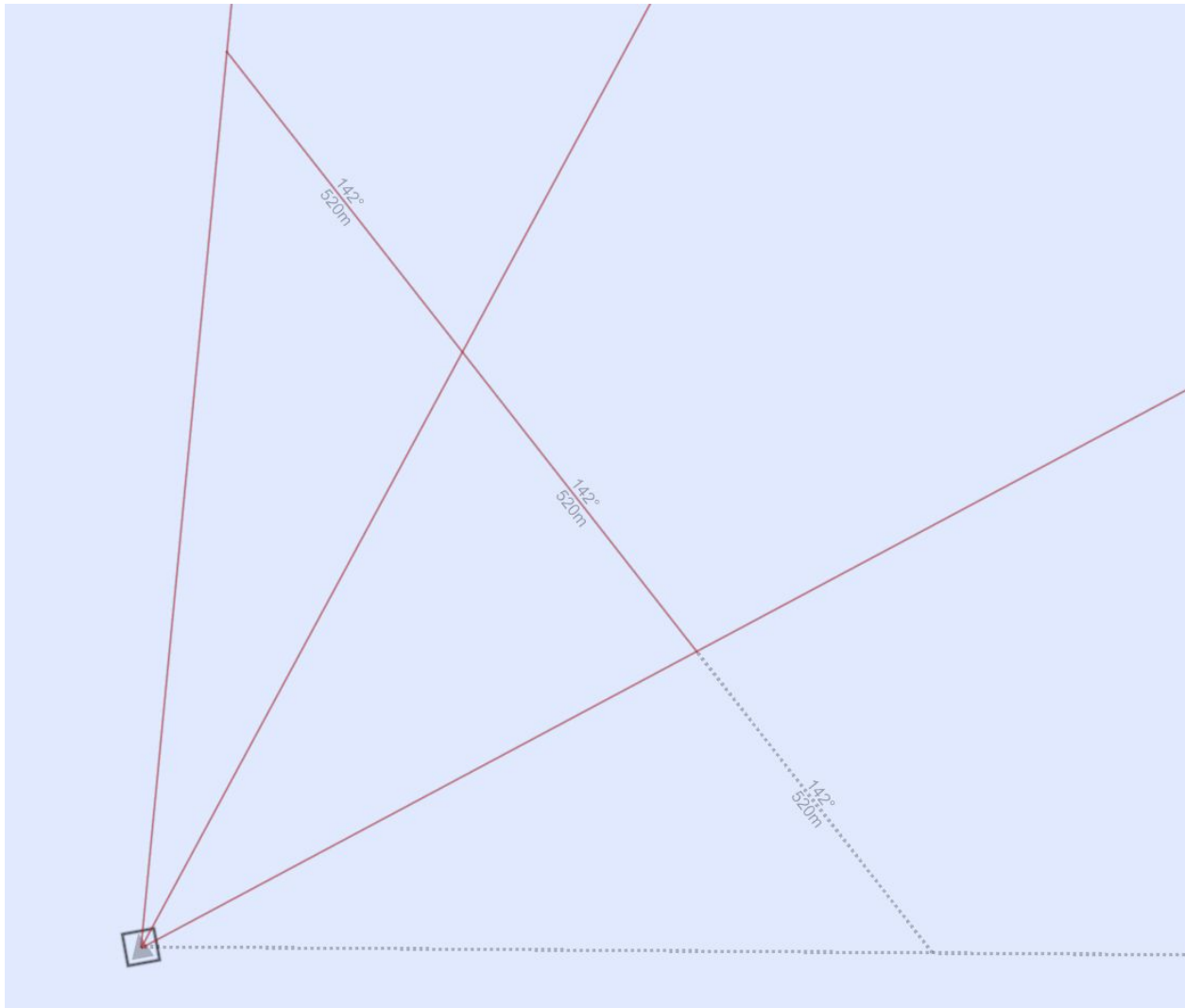

Since we know that the ship must be somewhere along this projected observation line when the interval is over, we can now triangulate it's true position.

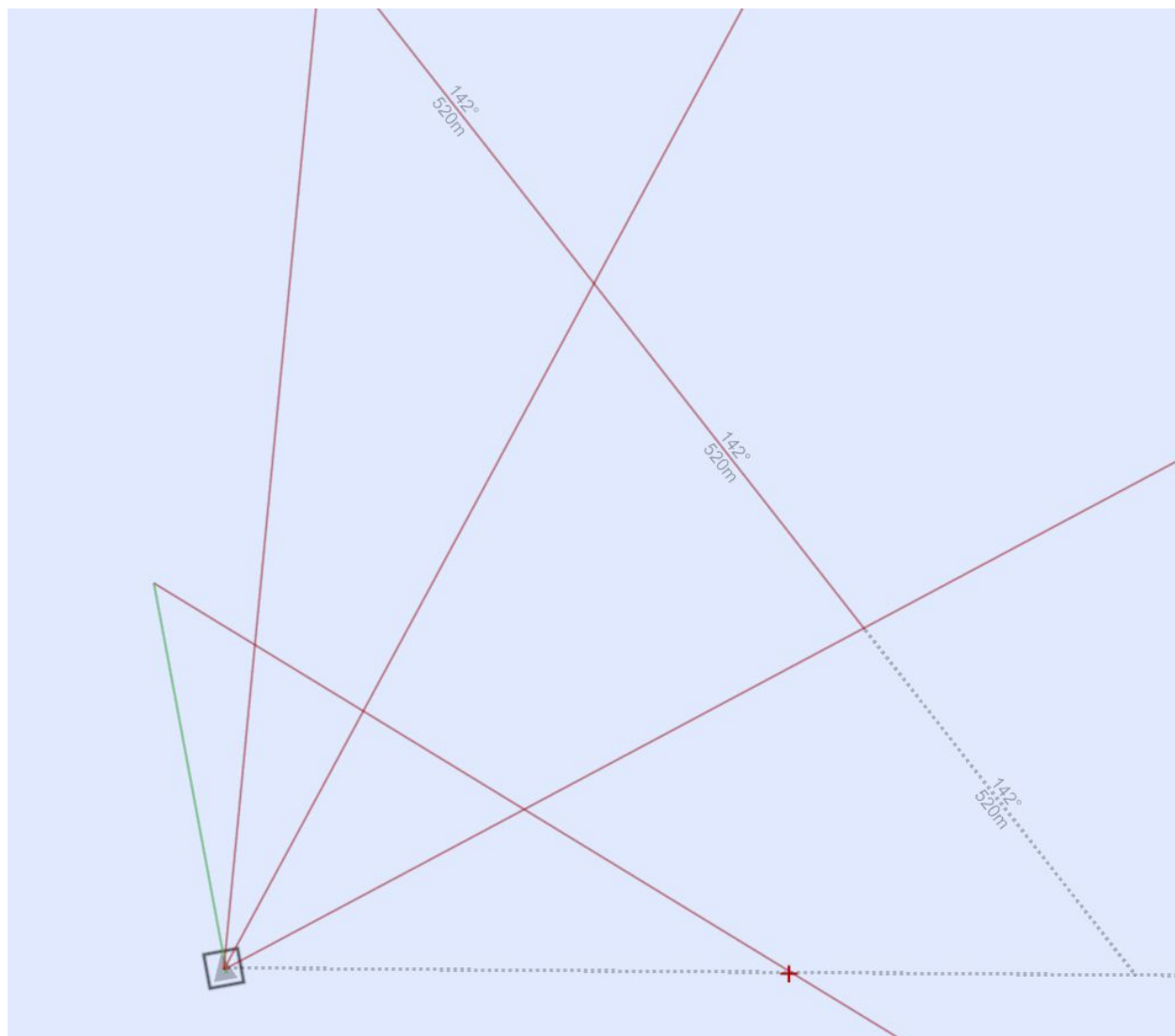

We now know the ship's position and course. We can now calculate the ship's speed using the timestamp and measure time tools.

